

Energy Conservation and CO₂ Emissions in the Processing and Use of Oil and Gas

D. Decroocq

► **To cite this version:**

D. Decroocq. Energy Conservation and CO₂ Emissions in the Processing and Use of Oil and Gas. Oil & Gas Science and Technology - Revue d'IFP Energies nouvelles, Institut Français du Pétrole, 2003, 58 (3), pp.331-342. 10.2516/ogst:2003020 . hal-02043866

HAL Id: hal-02043866

<https://hal-ifp.archives-ouvertes.fr/hal-02043866>

Submitted on 21 Feb 2019

HAL is a multi-disciplinary open access archive for the deposit and dissemination of scientific research documents, whether they are published or not. The documents may come from teaching and research institutions in France or abroad, or from public or private research centers.

L'archive ouverte pluridisciplinaire **HAL**, est destinée au dépôt et à la diffusion de documents scientifiques de niveau recherche, publiés ou non, émanant des établissements d'enseignement et de recherche français ou étrangers, des laboratoires publics ou privés.

Energy Conservation and CO₂ Emissions in the Processing and Use of Oil and Gas

D. Decroocq^{1*}

¹ Institut français du pétrole, 1 et 4, avenue de Bois-Préau, 92852 Rueil-Malmaison Cedex - France

* Formerly Scientific Director of IFP, now Secretary General, Scientific and Technical Consultant
of the French Norwegian Foundation, FFN-FNS

e-mail: decroocq.daniel@wanadoo.fr

This paper reproduces a lecture in french at the “Énergies et climat” one-day meeting
organised by the French *Académie des sciences*, 23 April 2001

Résumé — Économies d'énergie et émissions de CO₂ dans le traitement et l'utilisation des hydrocarbures — À l'horizon 2020, pétrole et gaz naturel, qui contribuent actuellement à hauteur de 62 % aux émissions anthropogéniques de gaz carbonique, devraient continuer à couvrir la moitié des besoins mondiaux d'énergie primaire. La lutte contre les émissions de CO₂ implique donc la mise en œuvre d'actions préventives en matière de traitement (raffinage des pétroles bruts et du gaz naturel) et d'utilisation (combustion en foyers fixes, transport automobile) des hydrocarbures fossiles ainsi que d'actions curatives visant à la captation et à la séquestration du CO₂ émis. Les solutions technologiques disponibles ou envisagées pour ce faire sont passées en revue dans le présent article.

Abstract — Energy Conservation and CO₂ Emissions in the Processing and Use of Oil and Gas — By the year 2020 or so, oil and gas, which contribute currently to 62% of the whole of carbon dioxide anthropogenic emissions, will go on to cover roughly half of the world demand of primary energy. Thence, the fight against the CO₂ emissions requires the implementation of preventive actions as regards processing (refining of crude oil and natural gas) and uses (combustion in boilers for energy production and engines for automotive transportation) of fossil hydrocarbons and curative actions aiming at the capture and sequestration of the given off CO₂. The appropriate technical solutions to do that are reviewed in this paper.

INTRODUCTION

Oil and natural gas which, in 1973, during the first oil shock, covered 69% of world primary energy demand, are likely to continue to play a major role in the coming decades [1, 2]. According to the prospects identified at the last World Energy Conference, world energy demand, rising steadily since 1960, driven by demographic growth and accelerated industrialization, could range from 11.5 to 13.6 billion tons (Gt) oil equivalent (toe) in 2020, compared with 8.5 in 1998 and 5.6 in 1973. Hydrocarbons, at the rate of 27% for oil and 24% for natural gas, will still account for 51% of world primary energy supply in 2020 (*Fig. 1*), while the fraction consumed for uses in which oil is not readily replaceable will reach 80% on this date [3]. At present, the combustion of oil and natural gas accounts for 62% of anthropogenic carbon dioxide emissions, which, after weighting for the radiative power of the gases concerned (CO_2 , CH_4 , N_2O , halogenated derivatives of carbon), are responsible for 64% of the corresponding greenhouse effect. The Kyoto Protocol imposes on the industrialized countries a 5.2% reduction in their carbon dioxide emissions from the 1990 level, over the 2008-2012 period. In consequence, the oil and gas industry must assume its share of the efforts made to achieve this. The fight against carbon dioxide emissions throughout the chain of processing and use of oil and gas implies the implementation of a goal oriented policy of preventive measures of energy conservation, higher energy efficiencies and reliance on new technological systems offering an economically viable alternative to the conventional use of fossil energies [4].

These preventive measures must naturally be supplemented with a set of curative measures aimed at the capture and sequestration of the carbon dioxide released.

This discussion, which cannot claim to be exhaustive, attempts to highlight a number of salient aspects of this problem.

1 CRUDE OIL REFINING AND HYDROGEN PRODUCTION [5]

The major trends which in recent years have characterized the evolution of the petroleum products market are likely to persist in the coming decade. At the quantitative level, we are witnessing the continued growth of the motor fuels market, essentially in favor of diesel oil and kerosene, whose annual consumption should reach growth rates of 3 to 4% worldwide.

A consequence of intensified dieselization of automotive vehicles in circulation, at least in Europe because the North American market is undeniably more stable, the diesel oil/gasoline ratio will clearly rise, raising the problem of a sufficient availability of middle distillates leaving the refinery.

On the whole, the consumption of petroleum products intended for transportation requirements will climb to significantly over half of total crude oil consumption by the 2020 horizon.

At the same time, the market for home heating oil and heavy fuel oils is steadily declining, displaced particularly by

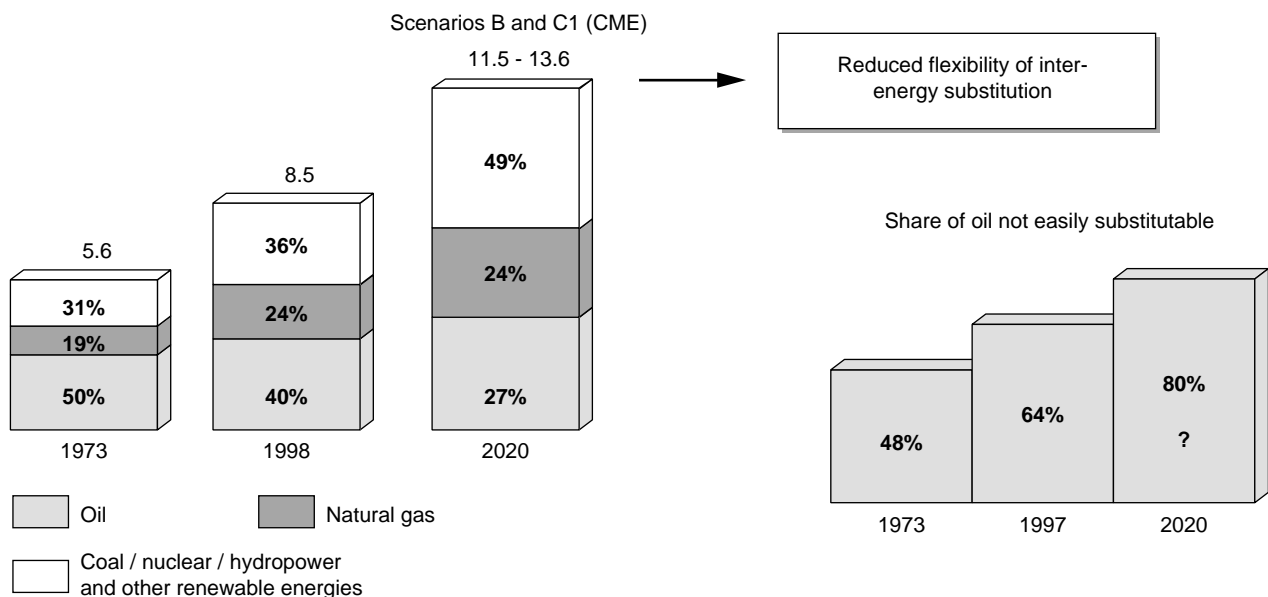

Figure 1

World demand for primary energy (1973-2020).

natural gas and renewable energies for heating, power generation, and energy supply to the industry [5, 6].

This drastic change in the use of oil in favor of transportation and, to a lesser extent, petrochemicals, durably affects the distribution of demand between light cuts, middle distillates and heavy cuts (Fig. 2) which in 2020 will account for no more than 10% of the world crude oil consumption.

At the qualitative level, environmental concerns and the resulting severization of the specifications of petroleum

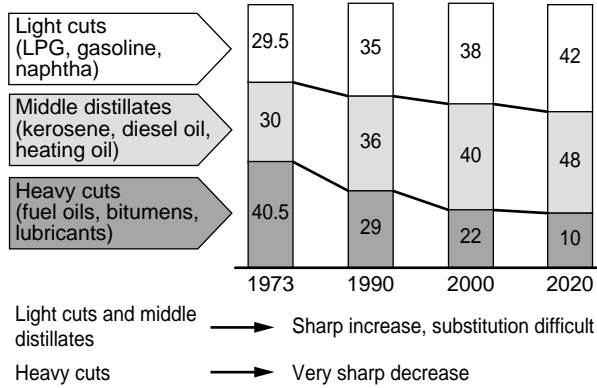

Source: IFP/DSEP.

Figure 2
 World market trends of petroleum products - Evolution of the demand structure (in weight %).

products, are also factors in the major evolution of refining [7]. In the United States, 30 ppm of sulfur in motor fuels seems to be the maximum admissible limit, while the future of oxygenated compounds, like methyl tert-butyl ether (MTBE), as base stocks for gasoline blends, appears uncertain, due to their high solubility in water and their low natural attenuation, in the wake of the Californian regulation that bans their incorporation from the end of 2002.

In Europe, by the 2005 horizon, the maximum sulfur contents of gasoline and diesel oil will be set at 50 ppm (Table 1), the maximum aromatics content in gasoline at 35% but many uncertainties still prevail concerning the olefins content in gasoline (less than 10% in 2010?) and polyaromatics in diesel oil (less than 2% in 2010?). The results of the work done in the Auto-Oil I and II research programs of the European Union are likely to shore up the standards to be adopted but an increase in the cetane demand, the decrease in polycyclic aromatic hydrocarbons (PAH) and final distillation point, if not yet quantified definitively for diesel oil, are already planned and will have a major impact on refining techniques (Table 1).

These quantitative and qualitative changes in the petroleum products market, added to potential variations in the types of crude processed, condition the outcome of the refining schemes and units (Fig. 3), a process initiated in the early 1980s.

In this context, the 2010-2020 refining scheme will hence chiefly focus on reducing the already steadily declining

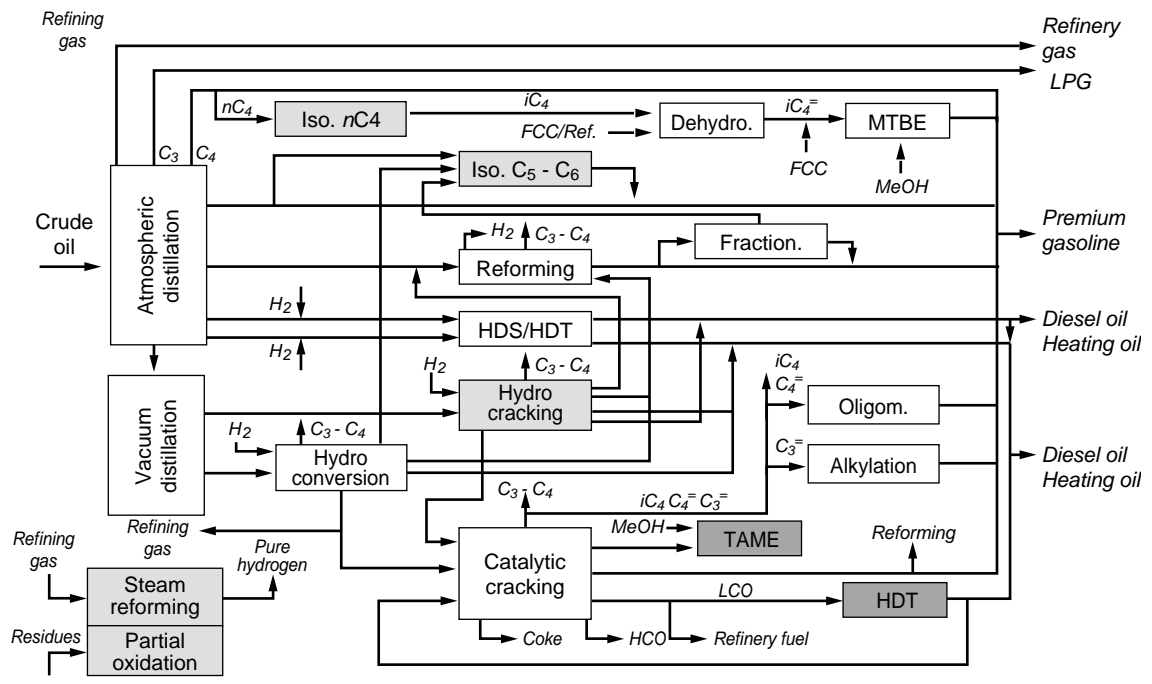

Figure 3
 2010-2020 refining scheme.

TABLE 1
Evolution of the gasoline and diesel fuel specifications
in the European Union

Gasoline	1996	2005	2010?
Sulfur	500 ppm	50 ppm	< 30 ppm
Benzene	5%	1%	< 1%
Aromatics	Not specified	35%	< 30%
Olefins	Not specified	8 to 18%	< 10%
Diesel oil	1996	2005	2010?
Sulfur	500 ppm	50 ppm	10-30 ppm
Cetane	49	51 to 55	> 55
Polyaromatics	Not specified	11 to 2%	1-2%
Density	860	845 to 820	< 840
T 95% (°C)	370	340 to 360	< 340

Source: IFP Refining/Petrochemistry Seminar 1999.

production of heavy fuel oils, as well as the production of motor fuels with ceaselessly improved performance. This is the concept of the no fuel refinery only producing light cuts and middle distillates for traction/propulsion and petrochemicals thanks to the conventional conversion of vacuum distillates and the deep conversion of surplus heavy residues from atmospheric distillation and vacuum distillation (*Fig. 3*).

These transformations entail a more or less complex combination of conversion and separation processes operating with carbon removal (coking, deasphalting, catalytic cracking), with the addition of hydrogen (converting hydro-treating, hydrocracking) or gasification (partial oxidation with production of hydrogen or synthesis gas).

Motor fuel reformulation [8, 9] makes use of numerous base stocks obtained by a wide range of processes (*Fig. 3*).

However, the most conventional, like alkylbenzene rich reformate obtained by aromatization (catalytic reforming) of heavy naphthas from straight-run distillation, catalytic cracked gasoline, rich in olefins, and oxygenated compounds (MTBE) are liable to find their relative importance decline due to their environmental impact. By way of compensation, this will lead for gasoline production to a stronger presence in the refining schemes of the future (*Fig. 3*) of units for the isomerization of light gasolines, the alkylation of light olefins by isobutene, the oligomerization/hydrogenation of olefins and, to satisfy the new sulfur content specifications, the deep hydrodesulfurization of catalytic cracked gasolines. Similarly, the production of low sulfur and high cetane diesels will require units offering deep hydrodesulfurization and hydrogenation of aromatic components. Reliance on top grade synthetic base stocks (cetane number above 70), like Fischer-Tropsch diesel oil and dimethyl ether (DME), obtained from synthesis gas (CO + H₂) produced by steam reforming of natural gas, will also be likely to help resolve the question of the diesel pool.

Given these sweeping changes, many major concerns will continue to dominate the problematics of refining operations in the coming decade: the total energy balance, the hydrogen availability and, in consequence, the environmental impact of refining in terms of greenhouse gas emissions in particular [10].

The progressive complexification of refining schemes is in fact causing a steady increase in investments, operating costs, as well as energy self-consumption of refineries (*Table 2*). Thus recent projections made by the Energy Group of the French Government Plan show that energy self-consumption could rise from 6.3 to 7% of the crude processed in France and 5.5 to 6% in the European Union at end 2002 [11]. The oil industry will therefore have to continue to install new technological solutions, less energy intensive, to contain this structural expansion and substantially improve the energy efficiency of the refinery.

TABLE 2
Influence of the refining complexity on the investment costs and energy self-consumption of refineries*

Type of refinery	Investments (Billion US\$)	Refining costs (\$/bbl)	Energy self-consumption (weight% of crude processed)	Hydrogen consumption (weight% of crude processed)
Hydroskimming	0.5	1.5	4-4.5	0.2-0.3
Conventional conversion	1-1.5 ⁽¹⁾	3-4	6-8	0.5-1
Deep conversion ⁽²⁾	2.5	7.5	11-13	1-1.5

* For a refinery with a processing capacity of 8 million tons of crude oil per year and installed in Europe.

(1) Depending on the grade of products.

(2) Including units aimed to improve product quality (specifications 2000).

Source: IFP/DSEP.

The severization of motor fuel specifications, added to the hydroconversion of vacuum distillates and residues, will also generate a sharp rise in hydrogen consumption of the refinery. For example, a hydrotreating unit producing a 50 ppm sulfur diesel oil consumes 4 to 7 kg of hydrogen per ton of diesel oil processed, depending on the type of feedstock. In consequence, the hydrogen requirements of a complex refinery processing 8 Mt/year of crude oil, equipped with deep conversion units and focused on the production of motor fuels meeting the European standards of 2005, amount to around 1 to 1.5% by weight of the crude processed, or about 100 000 t/year (Table 2). In fact, the catalytic reforming unit, which produces high octane gasoline base stocks and is the only process supplying hydrogen in a conventional refining scheme, is unable to satisfy such huge hydrogen needs. Accordingly, units dedicated to the production of hydrogen by partial oxidation of residues or steam reforming of natural gas (Fig. 3) will have to be installed, but at the price of a sharp increase in costs and carbon dioxide releases. Each ton of hydrogen produced from natural gas will release 11 t of CO₂, and the situation is even worse with residues (15 t of CO₂/t of H₂). While carbon dioxide emissions associated with refining only accounted for 4% of total CO₂ emissions in France in 1999, these emissions are destined to grow sharply in the next ten to fifteen years, an increase estimated at 40% of the present values in the European union as a whole. The processes of severization of motor fuel standards and of deep conversion of residues must therefore be balanced, to optimize their development, with the attendant increase in carbon dioxide emissions that raise a major difficulty for refining. This context is likely to encourage the development of new purification processes, that consume little or no hydrogen, for example, the biodesulfurization used as a finishing step.

2 HEAT AND/OR POWER GENERATION

In France, where 109 Mt of carbon were emitted in carbon dioxide in 1999, the heating of premises (25%), thermal power plants (9%) and energy supply to industry (21%) together account for 55% of the total of these emissions.

In the field of residential and tertiary heating, which represents 56% of home heating oil uses, of which French consumption amounted to 17 Mt in 1999, the efforts made to conserve energy have proved successful and annual decreases in the consumption of heating oil amounted to an accumulative 2.6 Mtoe between 1988 to 1997 [12]. The severization of home insulation standards and the improvement in the energy efficiency of boilers, above 90%, have hence effectively contributed to the decrease of CO₂ releases.

As regards power generation, which for years has been based exclusively on steam power plants burning coal, heavy fuel oil, nuclear fuel and sometimes gas, we have seen the

progressive emergence of many technological innovations responsible for a steady increase in energy efficiencies, and hence, for the same installed capacity, a concomitant decrease in carbon dioxide releases [13]. This marked by the advent primarily of power plants with high unit capacity (250 MW) natural gas turbines, comprising a hot air compressor, a combustion chamber and an expansion turbine supplied with flue gases and driving the compressor as well as an alternating-current generator.

Thanks to the technological advances achieved in metallic alloys and heat exchange, the admissible temperature levels at the first stage of the turbine are in the range of 1400°C, and this, associated with compression ratios of 30, helps today to reach energy efficiencies approaching 40% and hence comparable to those of the best conventional steam power plants.

A new step was taken by the use of the cycle combining a gas turbine with a steam turbine (Fig. 4). The exhaust gases from the gas turbine, which supplies 2/3 of the total installed capacity, are used in a waste-heat boiler. Since the outlet temperature of the gas turbine can reach 600°C, super heated steam at 550°C, gauged at 10 MPa, can be produced and serves to feed a two-or three-stage steam turbine. With the equipment available today, this produces energy efficiencies up to 60%. A combined cycle plant is composed of one or more sections, and the unit capacity of a section can reach 750 MW. Investment costs (500 to 700 \$/kW) is twice that of a gas turbine but half of that of a conventional steam power plant.

In refining, the search for a better upgrading of certain ultimate residues has led to the development of a new technology for the production of utilities: the integrated gasification combined cycle (IGCC) [14]. The elimination of all the impurities from the synthesis gas obtained in the gasification step, in order to supply the gas turbine without risk of damaging it, is nonetheless indispensable. A number

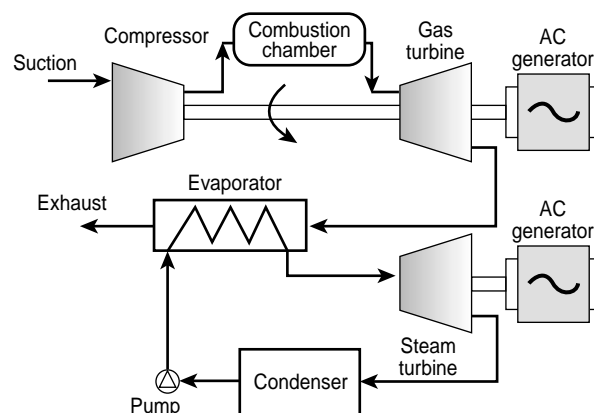

Figure 4

Combined cycle for power plant.

of installations of this type are in operation in Europe, chiefly in The Netherlands and Italy. The energy efficiency of an integrated gasification combined cycle plant is around 45%. This is a very clean technology in environmental terms, but its investment cost remains high.

The latest arrival, cogeneration [15] or the combined production of work and heat, covers a set of techniques simultaneously delivering mechanical energy, usually employed to produce electricity by coupling with an a.c. generator, and heat energy. The basic advantage of these techniques resides in the fact that the conventional mechanical efficiency, around 40%, is doubled thanks to the recovery and use of the energy contained in the combustion gases and in the cooling circuits of a heat engine. At equivalent electricity and heat production, the total quantity of primary energy required, in the example in Figure 5, is thus 100 for the cogeneration system instead of 153 for separate units, representing a fuel economy of 35%. Different flowcharts can be found including:

- coupling of a conventional steam generator with a steam turbine;
- coupling of a gas turbine with a waste-heat exchanger placed on the exhaust gases;
- combined cycles associating a gas turbine with a waste-heat boiler with post-combustion to which is added a steam turbine which expands the high pressure steam produced by the boiler. The low pressure steam leaving the turbine supplies the heat distribution circuit;
- coupling of an a.c. generator with waste-heat exchangers running on drive fluids and exhaust gases.

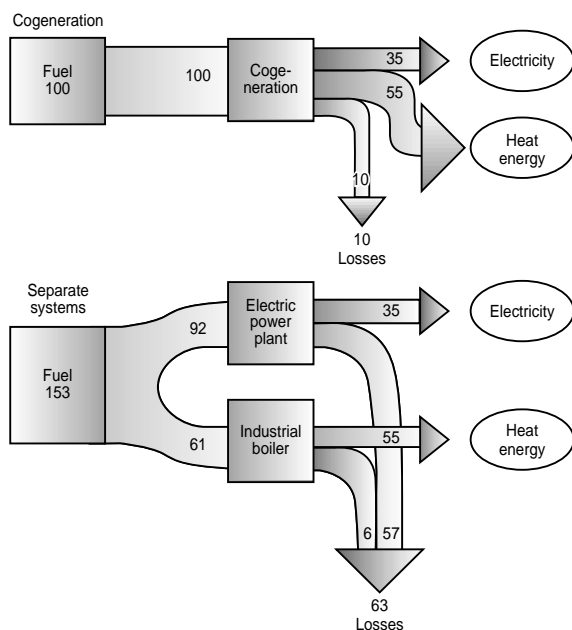

Source: Pétrole et Techniques n° 417 (1998)

Figure 5
Energetic balance of cogeneration.

The variety of technical solutions available in co-generation today helps to meet very broad needs for electric power ranging from a few hundred kilowatts with a.c. generators to several megawatts using gas turbines, and even a few hundred megawatts for the large combined cycle or steam power plants. In Europe, The Netherlands, to supply electricity, and Germany, for heat networks, enjoy a significant lead in the field of cogeneration, while the United States is installing around 3000 MW of electric capacity obtained by cogeneration every year.

3 THE PROBLEMATICS OF AUTOMOTIVE TRANSPORT: THE ENGINE-FUEL COMBINATION [16, 20, 21]

The environmental impact of road transport, which is growing steadily due to the increase in the number of vehicles and their annual mileage, remains a major social concern and hence continues to be the focus of a massive technological research and development effort aimed to fight against all the forms of air pollution for which it is responsible and whose impact on health and climate are henceforth universally acknowledged [16]. The stiffening of regulations in terms of emissions of private cars [17] has encouraged spectacular technological breakthroughs which, in the space of some thirty years, have helped to halve (*Fig. 6*) the exhaust releases of the main pollutants (CO, NO_x, unburnt hydrocarbons, particulates) thereby providing, at the local scale, a significant improvement in urban air quality. These results have been obtained thanks to the advances in fuel formulations, the management of the air-fuel mixture, optimization of combustion in engines, and above all, post-treatment of effluents (three-way catalysis, oxidation catalysis, particulate filters) in the exhaust line.

At a more global scale, that of the greenhouse effect, road transport contributes worldwide to 23% of anthropogenic carbon dioxide releases and vigorous measures are also implemented to reduce fuel consumption and hence the corresponding carbon dioxide emissions at equivalent service. The prospects announced by the *Association of European Automotive Manufacturers (ACEA)* appear particularly ambitious in this respect (*Fig. 7*). While in 1997 the average consumption of private cars built that year in Europe, all makes and vehicle types combined, amounted to 7.2 l/100 km (33.5 mpg), the ACEA has set a consumption target of 5.3 l/100 km (48 mpg) in 2008 and 4.5 l/100 km (52 mpg) in 2012. These values correspond to CO₂ emissions of 140 g/km and 120 g/km, the European Parliament recommending an even more drastic reduction to 90 g/km in 2010. Significant advances have certainly been made in this direction, imposed by geopolitical, industrial and economic constraints of fuel availability and cost, but many

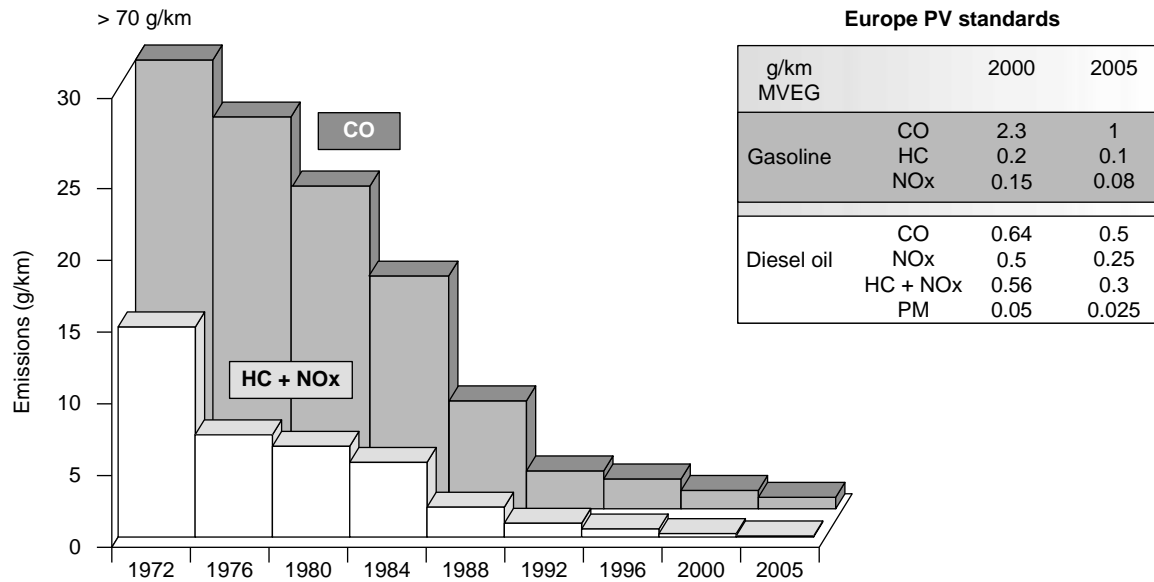

Figure 6 Evolution of the antipollution regulations since 1970 for the private cars.

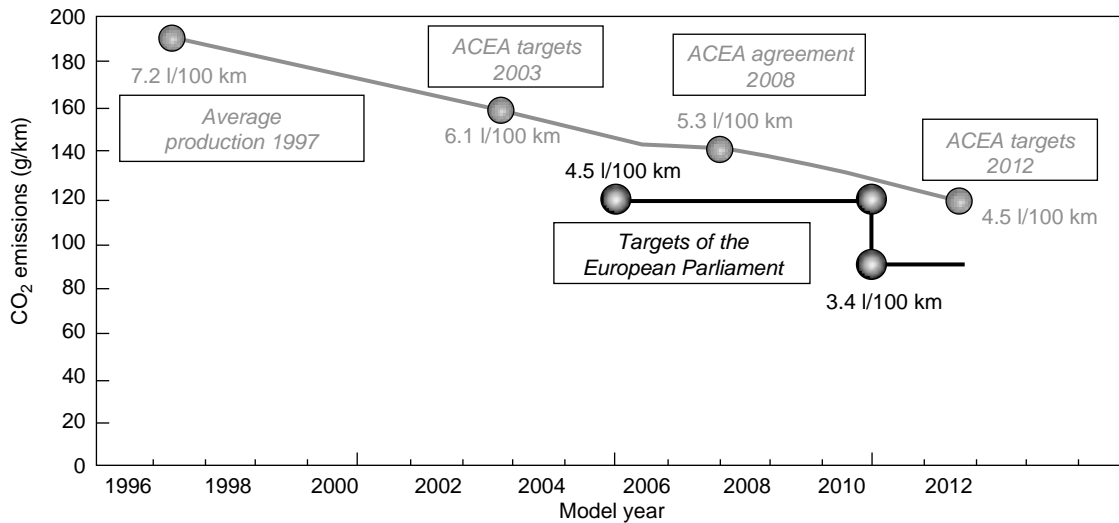

Figure 7 Scenario of cut in CO₂ emissions of private cars for the European Union.

technological breakthroughs are still needed to reach the above values, especially since the growing sophistication of vehicle attachments (air-conditioning, for example) tends to increase fuel consumption [18]. By way of illustration, Figure 8 positions the performance of private cars with manual gearshifts manufactured by German automakers between 1997 and 1999. We find that their carbon dioxide emissions, with the exception of direct injection diesel vehicles, are still substantially higher than the future 2008

and 2012 standards shown in the graph by horizontal lines. Besides, it must be also be remembered that the penetration of an innovation into the existing automobile fleet is a very slow process which demands a decade or so to affect more than half of the fleet.

Apart from the reformulation of conventional fuels (gasoline, diesel oil) already addressed with respect to refining, the work done to reduce carbon dioxide emissions is structured along three force lines (Fig. 9): the improvement

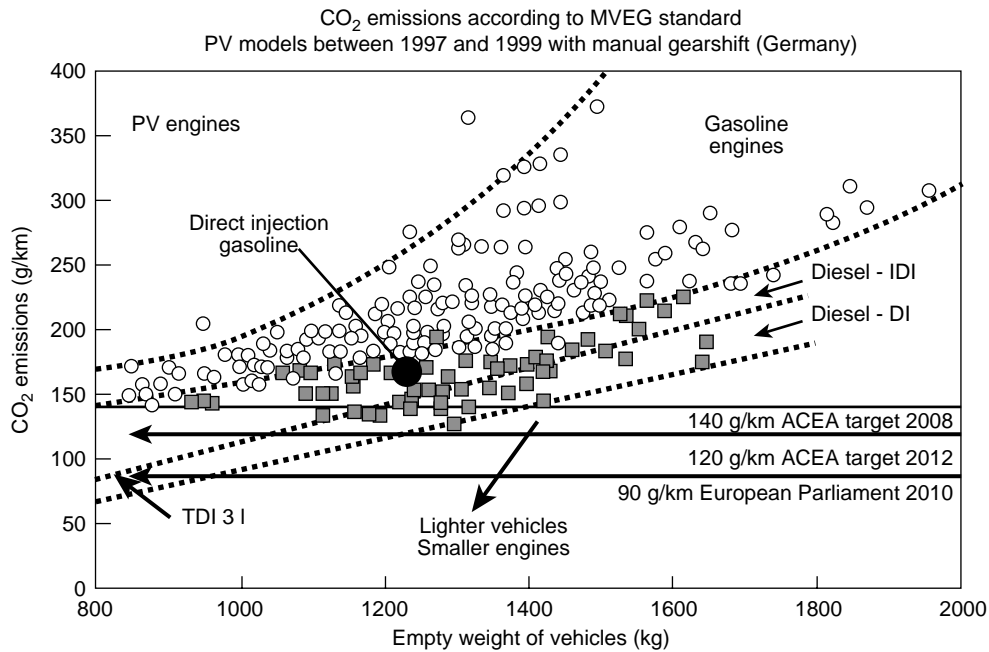

Figure 8

Performances of a group of German private cars compared with the future standards of CO₂ emissions.

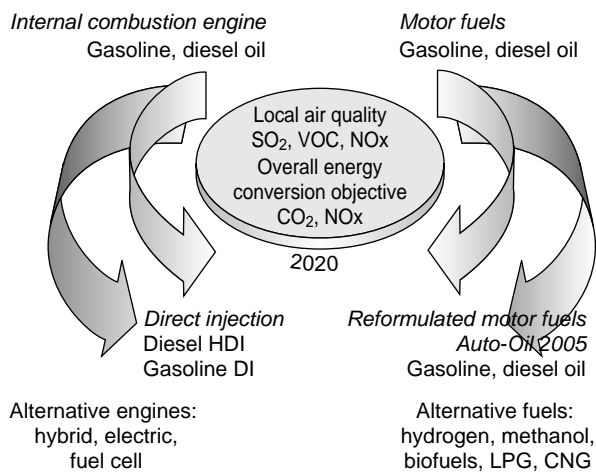

Figure 9

Energy savings and emissions decreasing: the coupling engine-fuel and the ways of their technical improvement.

of conventional heat engines (spark ignition and diesel engines), the use of new fuels (biofuels, liquefied petroleum gas LPG, compressed natural gas CNG, hydrogen and methanol) and the development of alternative engines (hybrid, electric with battery or fuel cell) [19-21].

As to gasoline engines, miscellaneous technical variants such as the recycling of a fraction of exhaust gases, which improves efficiency and decreases nitrogen oxides, have

been implemented but a decisive step was taken with direct injection of the fuel into the cylinder, a technology that provides many advantages: the possibility of using higher compression ratios, better heat efficiency, reduced consumption or over consumption particularly during cold startings, better response during transient operating phases. Thanks to direct injection, two alternative engine combustion modes are available:

- a conventional mode operating at stoichiometry and treating the exhaust gases in a three-way catalytic converter;
- a stratified feed mode operating with total excess air, the stratification of the feed allowing a sufficient local fuel-air ratio at the spark plug to ensure starting followed by correct propagation of combustion.

It is basically advances in electronics which, by offering great flexibility in injection and ignition controls, have enabled the optimal control of these engines running on lean mixtures [21-22].

Direct fuel injection and control of stratified combustion make it possible to approach the efficiency of diesel engines and to cut consumption by 15 to 30% (Fig. 8). On the other hand, running with excess air is incompatible with the treatment of effluents by three-way catalysis and hence increases NO_x emissions. To make the most of their advantages in terms of efficiency and carbon dioxide release, the direct injection gasoline engines of the future will therefore have to try to control their nitrogen oxide emissions.

If we now turn our attention to the diesel engine, we find that the increase in the penetration rate of diesel vehicles in European cars in circulation, which was 28% in 1999 and which could reach 40% in 2010, propelled by the better efficiency of the diesel engine compared with the gasoline engine, already tends to reduce consumption and hence carbon dioxide releases.

Historically, the development of the diesel engine for private cars was associated with the adoption of the so-called precombustion chamber technology, which consists in injecting the diesel oil into an auxiliary volume of the main chamber whose geometry is designed to generate strong turbulence. This process helps to initiate and propagate combustion in conditions that favor the lowering of noise and smoke, at the cost of higher heat losses, which accordingly lower the efficiency. Subsequently, the generalization of the multi-valve and supercharging techniques, designed to increase the quantity of air intake per cycle, but above all, the progressive adoption of direct injection, which was until recently reserved for trucks and utility vehicles, has led to a significant increase in performance both in terms of torque, power, pollutant emissions, noise and, in general, driving comfort. In this context, two major technologies have been developed: the pump injector and the common rail high pressure injection [21, 22].

Combined with an increasingly complex electronic power system, the pressure levels reached, from 130 to 200 MPa, favor a very fine fuel spray, thereby guaranteeing immediate vaporization and very good mixing quality with comburent air. Moreover, the 3D numerical simulation of the hydrodynamics/transfers/chemical reactions coupling has allowed a very accurate geometric design of the intake manifolds and the combustion chamber. The combination of these technologies, the lightening of the moving parts and the decrease in friction have offered many advantages to second generation diesel engines, affecting the reduction of consumption, the NO_x/particulates compromise and ease of control. Direct injection accordingly decreases consumption by about 15% compared with the precombustion chamber diesel engine, while the latter already offers a similar gain over the conventional gasoline engine. To offset its low carbon dioxide emissions (*Fig. 8*), the diesel engine remains handicapped by substantially higher NO_x and particulate emissions than its gasoline counterpart equipped with a three-way catalytic muffler. Hence the importance of the work done on DeNO_x catalysis, whose implementation will be favored by lowering the sulfur content of the diesel oil, and particulate filters.

Finally, for the heat engines of the future, great hopes are placed in the development of new combustion modes (auto-ignition controlled by maintaining a residual fraction of burnt gases in the cylinder for the gasoline engine or homogeneous combustion for the diesel engine) which, by introducing new requirements on motor fuels, will also, if they prevail in the

future, put into question the very representativity of the octane and cetane numbers to qualify combustion in piston heat engines.

Among liquid alternative fuels [20] are biofuels used in small proportions in conventional fuel formulations. This is the case, for example, of vegetable oil methylesters (rape, sunflower) whose incorporation in proportions lower than 5% in diesel oil is perfectly tolerated by modern diesel engines, as demonstrated by many studies in France and Italy, and is accompanied by a slight reduction in pollutant emissions. Ethanol, obtained from cereals, beets and sugar cane (Brazil) can be used as gasoline, either alone or in a mixture, but in the latter case, it is preferably incorporated in the form of ethyl tert-butyl ether, which displays better compatibility with hydrocarbons.

The use of gaseous fuels in place of gasoline offers definite advantages in terms of energy efficiency and pollutant emissions, without demanding major engine modifications. Compared with gasoline, liquefied petroleum gas (LPG), accessible at moderate cost, can cut carbon dioxide emissions by 10%, and its importance is amply demonstrated, chiefly on specialized fleets (taxis, light utility vehicles, urban buses).

Similarly, reliance on compressed natural gas (CNG) at 20 MPa is a tried and proven solution concerning 500 000 vehicles today worldwide. On engines adjusted accordingly, the CNG procures significant advantages which offset a costly energy supply. The energy efficiency is about 10% higher than gasoline engines but still inferior to direct injection diesel engine performance, while carbon dioxide emissions are cut by 20%. Its chief drawback concerns storage, which is highly penalizing from the weight, size and safety standpoint, although the use of composites should ultimately improve its prospects.

This brings us to the direct use of hydrogen as an automotive fuel. While it offers advantageous combustion properties (high propagation velocity, extended operating range in lean mixture and absence of CO₂ in the burnt gases), its use nonetheless raises many problems: low resistance to auto-ignition limiting the compression ratio, detonating power, low energy content per unit volume, and above all problems of storage and safety. Hydrogen can be stored either compressed at 20 MPa, in liquid form in cryogenic tanks, or converted to metallic hydrides, but none of these alternatives is fully satisfactory. To circumvent these difficulties, the focus has shifted to potential hydrogen precursors, such as methanol, which can be stored easily in liquid form and which supplies hydrogen by decomposition in an onboard reformer.

To complete this review, and although this point is not at the heart of this review dedicated to the uses of oil and gas, it is also important to mention the work on the development of alternative engines, essentially electric, for which some studies predict that they could occupy a market share of

about 10% for private cars by the 2010-2015 horizon. Electric vehicles can carry energy in two forms: batteries or fuel. In the former case, the most widespread batteries (Ni-Cd or Li-C) only give electric vehicles a short range, around 100 to 200 km, posing a major obstacle to their spread and in any case limiting their use to urban zones. In the latter case, the fuel, in this case hydrogen, stored under pressure or produced in an onboard methanol reformer for example, is converted to electricity in an electrochemical cell (fuel cell). For applications to electric vehicles, the most classic ones run at low temperature and include Pt/graphite electrodes and electrolytic membranes of perfluoric acid polymer. Fuel cell vehicles are currently the subject of many research and demonstration programs because they offer the advantage of eliminating the problem of range, for vehicles equipped with an onboard methanol reformer.

The major advantage of electric vehicles over conventional heat engines is their zero or low level of pollutant emissions. Their drawbacks include the weight and size of the equipment (battery, cell, onboard reformer) but above all their cost, which is particularly high because the series effect is still negligible, and this considerably hampers their development and limits their use to specialized fleets.

In many respects, the hybrid vehicle, which combines a heat engine with an electric engine, therefore seems to be more promising. This combination is effected through a series-parallel coupling where the energy released by the heat engine can be sent either to the wheels, or via a generator to battery storage (Fig. 10). The hybrid vehicle is distinguished by high energy efficiencies, 50 to 80% higher than heat engines, and pollutant emissions reduced by a factor of 2 to 5, thereby accumulating the advantages of the two types of engine, while minimizing their drawbacks: elimination of pollutants in urban zones by use of the electric engine, long range and driving comfort of a heat engine on the road.

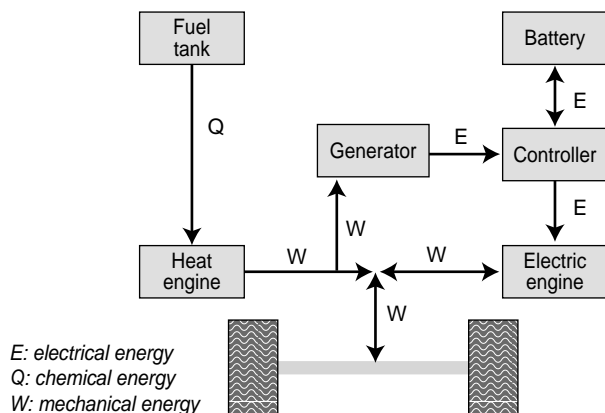

Figure 10
 Combinations of heat and electric engines for hybrid vehicle.

The success achieved in Japan by the first versions of hybrid vehicles appears to promise them a fine future, provided this category of vehicle can be proposed at a competitive price. It must also be pointed out that in the case of a fuel cell running on hydrogen, obtained by the decomposition of methanol, a hybrid solution is indispensable because the only one compatible with the transient phases of the use of the vehicle.

In terms of carbon dioxide emissions, to be able to compare the respective advantage of these different technologies, it is nonetheless indispensable to go beyond the performance of the converters and to make an overall balance “from well to wheel” [23] of the entire production/use chain (Fig. 11). Thus for conventional fuels, carbon dioxide is primarily emitted during their combustion in heat engines, while the refining of gasolines and diesel oils only makes a modest contribution to the overall balance. In the case of hydrogen, the opposite situation prevails: its production from hydrocarbons and/or methanol is in fact highly penalizing in terms of CO₂ emissions, although its combustion inherently only liberates water.

From the analysis of fuel systems and conventional and alternative engines (Fig. 11), it appears that the direct injection diesel engine, featuring high performance and massively distributed, represents the technological solution whose short term impact is greatest on the reduction of CO₂ emissions. The use of natural gas in a combustion engine optimized for this type of fuel also represents a valid alternative. Besides, subject to a more detailed ecological balance, fuels produced from biomass represent a method for recycling carbon dioxide, via photosynthesis, which merits consideration.

Conversely, the use of hydrogen obtained from fossil energy, even in a high efficiency converter like the fuel cell, does not seem to offer any considerable advantage [24] over

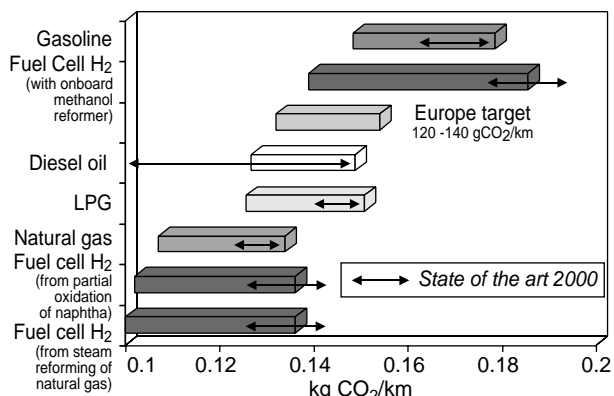

Figure 11
 Well-to-wheel CO₂ emissions for various cars technologies.

the above alternatives in terms of the absolute quantities of CO₂ emitted (*Fig. 11*). It must nonetheless be observed that the CO₂ releases associated with the production of hydrogen occur on the same site, in concentrated form, and not diluted and dispersed at the outlet of automobile exhaust pipes.

4 CURATIVE MEASURES: CAPTURE AND SEQUESTRATION OF CARBON DIOXIDE [25]

In conclusion, we can mention the guidelines aimed to remedy carbon dioxide emissions, followed in terms of curative measures of capture and sequestration.

For concentrated emission sources, in a thermal power plant for electricity generation for example, carbon dioxide can only be captured after or before combustion (*Fig. 12*). Decarbonation after combustion involves the treatment of the flue gas of the plant and, to be effective and economically viable, this must be done preferably on effluents relatively rich in carbon dioxide, which presumes the combustion with pure oxygen and not air. Various processes can be used in the actual carbon dioxide separating step: liquefaction or fractional distillation, adsorption, selective diffusion through membranes and above all absorption in amine aqueous solutions. The supplementary flue gas treatment causes a decrease in the overall energy efficiency of 15% for a combined cycle plant and a significant additional cost per kilowatt hour produced.

Decarbonation before combustion is based, for example, on the fabrication on a hydrogen rich fuel by steam reforming or partial oxidation of hydrocarbons, conversion of carbon monoxide from the synthesis gas obtained and capture of the carbon dioxide, while the hydrogen enriched

gas obtained is used to supply the thermal power plant. Note also that decarbonation before combustion is the only feasible method to effectively fight against carbon dioxide emissions by a large number of small dispersed sources.

The sequestration of the carbon dioxide thus recovered can be permanent or temporary, passive or active, and makes use of the three states of matter: gas, liquid, solid. Among the available alternatives, although many unknowns still subsist at this stage, are the following:

- Injection in geological formations of high porosity and permeability with sealed layer at the top: confined or open aquifers, depleted or active oil and gas reservoirs, coal seams, fractured limestone formations. The processes responsible for trapping are hydrodynamic and structural, physicochemical (dissolution) or chemical (carbonate formation).
- Injection in oceans in gaseous form at shallow depth, compressed and mixed with seawater at medium depth (200-300 m), in the liquid state around 1000 m depth or at even greater depth with the possible formation of hydrates.
- Biochemical sequestration by land and marine ecosystems.

ACKNOWLEDGEMENTS

The author is grateful to MM. Alain Morcheoine (*ADEME*), André Douaud (*IFP*), Philippe Pinchon (*IFP*), Jean-Bernard Sigaud (*IFP*), Colin Baudouin (*IFP*), Jean-François Gruson (*IFP*), Stéphane His (*IFP*), Jean-Pierre Jonchère (*IFP*) for all the elements that they have communicated.

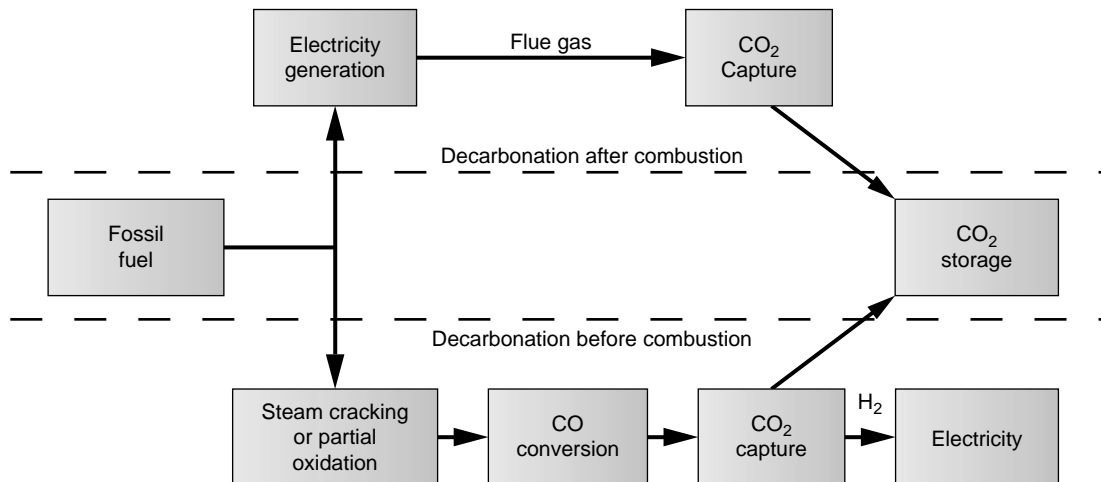

Figure 12

Fossil fuel power plant and elimination of CO₂ from flue gas.

REFERENCES

- 1 Boy de la Tour, X. (1999) The Energy future to 2020. *Oil & Gas Science and Technology*, hors série.
- 2 Directorate General for Energy (1996) European Energy to 2020. DG XVII/*European Commission Special Issue*.
- 3 Germain, J. (2000) Pétrole et Gaz dans le panorama énergétique mondial. *Rapport IFP 53 065*.
- 4 Jaecker-Voirol, A. (2000) Réduction des émissions polluantes et du CO₂. État des connaissances et des recherches dans le monde. *Rapport IFP 53 244*.
- 5 Decroocq, D. (2000) Raffinage : perspectives et prospectives. *Revue Pétrole et Techniques*, **429**, 106.
- 6 Gassler, J.P. (2000) Évolution des produits et de la consommation pétrolière française au cours des vingt dernières années. *Revue Pétrole et Techniques*, **429**, 70.
- 7 Gassler, J.P. (2000) Double enjeu pour les produits pétroliers du futur : un usage propre et économe. *Revue Pétrole et Techniques*, **429**, 111.
- 8 Courty, P. (1996) Défis présents et futurs du raffinage. *Rapport IFP 42 741*.
- 9 Courty, P. (1998) Raffinage, pétrochimie et protection de l'environnement : les nouveaux défis. *Rapport IFP 44 832*.
- 10 Courty, P. (2000) Refining Clean Fuels for the Future. *ENI Technology Seminar*, Milano, November.
- 11 Fournier, G. (1999) Économie d'énergie en raffinage. *Revue Pétrole et Techniques*, **422**, 62 et **424**, 61.
- 12 Fuel domestique : enjeux et performances (1997) *Conférence AFTP, 25 septembre 1996*. In *Revue Pétrole et Techniques*, **406**, 62.
- 13 Jonchère, J.P. (2000) Synergie gaz/électricité attractive pour l'environnement et option de moindre coût. *Revue de l'énergie*, **519**, 420.
- 14 Gourlia, J.P. (2000) L'avenir de la co-génération dans le raffinage. *Revue Pétrole et Techniques*, **424**, 72.
- 15 Hafner, M. (1999) Les turbines à gaz, les cycles combinés et la co-génération. *Revue Pétrole et Techniques*, **417**, 8.
- 16 Pollution atmosphérique due aux transports et santé publique (1999). *Rapport commun n° 12 de l'académie des sciences et du CADAS*, Paris.
- 17 Castex, L. (2000) Primequal/PREDIT 1997 ; Réglementation des polluants émis par les transports routiers : États-Unis, Europe, Japon - Rapport final. *Rapport IFP 53 226*.
- 18 Morcheoine, A. (2000) Transports, énergie, environnement : quels enjeux ? *Rapport ADEME*.
- 19 Douaud, A. (1994) Tomorrow's Engines and Fuels. *Conference Setting the Pace with IFP for the 21st Century*, Paris, June.
- 20 Douaud, A. (1996) Quels carburants pour les moteurs de demain ? *Euroforum*, Paris.
- 21 Douaud, A. and Girard, C. (1998) Les nouvelles technologies de moteurs et de carburants pour les transports routiers. *Revue Pétrole et Techniques*, **416**, 7.
- 22 Porot, P. and Duret, P. (1999) Recent Developments in Automotive Engines. *Oil & Gas Science and Technology*, hors série.
- 23 His, S. and Gruson, J.F. (2000) Comparaison des filières piles à combustible avec les convertisseurs conventionnels pour le transport : bilan énergétique et analyse des cycles de vie. *Rapport IFP 54 333*.
- 24 Douaud, A. (2000) Bilan CO₂ comparé PAC/moteurs conventionnels dans les applications transport. *Revue Pétrole et Techniques*, **426**, 70.
- 25 Giannesini, J.F. (2001) Conférence IFP. *Panorama*.

Final manuscript received in October 2002