

Analysis of the Particulates Emitted by Internal Combustion Engines

L. Forti, N. Jeuland, S. Raux, M. Pasquereau

► **To cite this version:**

L. Forti, N. Jeuland, S. Raux, M. Pasquereau. Analysis of the Particulates Emitted by Internal Combustion Engines. Oil & Gas Science and Technology - Revue d'IFP Energies nouvelles, Institut Français du Pétrole, 2005, 60 (6), pp.995-1010. 10.2516/ogst:2005070 . hal-02017268

HAL Id: hal-02017268

<https://hal-ifp.archives-ouvertes.fr/hal-02017268>

Submitted on 13 Feb 2019

HAL is a multi-disciplinary open access archive for the deposit and dissemination of scientific research documents, whether they are published or not. The documents may come from teaching and research institutions in France or abroad, or from public or private research centers.

L'archive ouverte pluridisciplinaire **HAL**, est destinée au dépôt et à la diffusion de documents scientifiques de niveau recherche, publiés ou non, émanant des établissements d'enseignement et de recherche français ou étrangers, des laboratoires publics ou privés.

Analysis of the Particulates Emitted by Internal Combustion Engines

L. Forti¹, N. Jeuland¹, S. Raux¹ and M. Pasquereau¹

¹ Institut français du pétrole, 1 et 4, avenue de Bois-Préau, 92852 Rueil-Malmaison Cedex - France
e-mail: laurent.forti@ifp.fr - nicolas.jeuland@ifp.fr - stephane.raux@ifp.fr - michel.pasquereau@ifp.fr

Résumé — Analyse des particules émises par la combustion dans les moteurs — Les émissions de particules des véhicules à moteur Diesel sont aujourd'hui réglementées et limitées de façon globale par une mesure sur cycle de conduite. Ainsi, un débit connu de gaz d'échappement dilués est prélevé et filtré. La pesée du filtre avant et après l'essai permet la détermination de la masse de suies émise par le véhicule. Si ces valeurs sont utiles pour limiter la pollution des véhicules, elles ne permettent pas aux chercheurs de répondre à toutes leurs interrogations. En effet, ceux-ci ont besoin d'informations plus précises sur la nature et la composition des particules afin, par exemple, de mieux comprendre et modéliser les phénomènes régissant leur formation. Ces informations permettent aussi d'en connaître la toxicité, de comparer de façon plus fine les émissions de différents types de moteurs, Diesel ou à allumage commandé, ou encore d'évaluer l'influence du carburant, du lubrifiant ou du système de post-traitement. Ces données sont donc utiles à la fois aux secteurs de l'automobile, du pétrole, de la santé et de l'environnement. Les différentes méthodes de prélèvement et d'analyse présentées permettent ainsi d'accéder à ces informations plus complètes sur les particules, telles que la teneur en composés volatiles ou solubles, la teneur en sulfates, en composés aromatiques polycycliques, en métaux, etc.

L'intérêt de ces analyses est montré au travers de résultats de différentes études ayant trait, par exemple, à la formation des particules ou à l'influence, sur celles-ci, de la technologie moteur ou du carburant.

Ces travaux nous permettent de dégager des axes de progrès pour l'évolution des méthodes d'analyse existantes ou pour définir de nouvelles procédures analytiques qui pourraient ouvrir de nouvelles perspectives aux chercheurs.

Abstract — Analysis of Particles Emitted by Combustion in Engines — Diesel engine particulate matter (PM) emissions are nowadays globally regulated and limited through a driving cycle measurement. Thus, a known flow of diluted exhaust gases is sampled and filtered. The weighing of the filter before and after the test allows the determination of the soot mass emitted by the vehicle.

If these values are useful to limit the pollution of the vehicles, they do not make it possible to the researchers to answer all their interrogations. Indeed, those need more precise information on the nature and the composition of the particles so, for example, to better understand and simulate the phenomena governing their formation.

This information also makes it possible to know their toxicity, to compare in a finer way the emissions of various types of engines, Diesel or spark ignited, or to evaluate the influence of the fuel, the lubricant or the after-treatment system. These data are useful for both the car manufacturer and petroleum industry and also for professionals of health and those of environment. The various methods of sampling and analyses here described make it possible to obtain this more complete information on the particles such as the volatile or soluble compound contents, the content of sulphates, polycyclic aromatic compounds, metal, etc.

The interest of these analyses is shown through results of various studies referring, for example, to the formation of the particles or the influence, on those, of the engine technology or of the fuel properties. This work enables us to propose axes of progress for the evolution of the existing methods of analysis or to define new analytical procedures, which could open new perspectives to the researchers.

INTRODUCTION

Particulate emissions from Diesel engine exhausts have been limited by regulations, since more than 20 years in Europe, mainly because of their impact on health. Legislation is based on particulate mass and maximum admitted levels are more and more stringent. Nevertheless, recent toxicological studies have shown that health effects may not only be dependent on total particulate mass. Their size and also their composition

are important parameters, which could explain their effects. Diesel exhaust particles are made of a carbonaceous skeleton onto which a lot of organic and inorganic compounds are adsorbed. The knowledge of the nature and proportion of chemical species in particulates is a key issue for researcher. This paper proposes to remind what are particulates, their sources and their effects, to describe some systems and methods to quantify and analyse them and to show what these analyses bring to researcher.

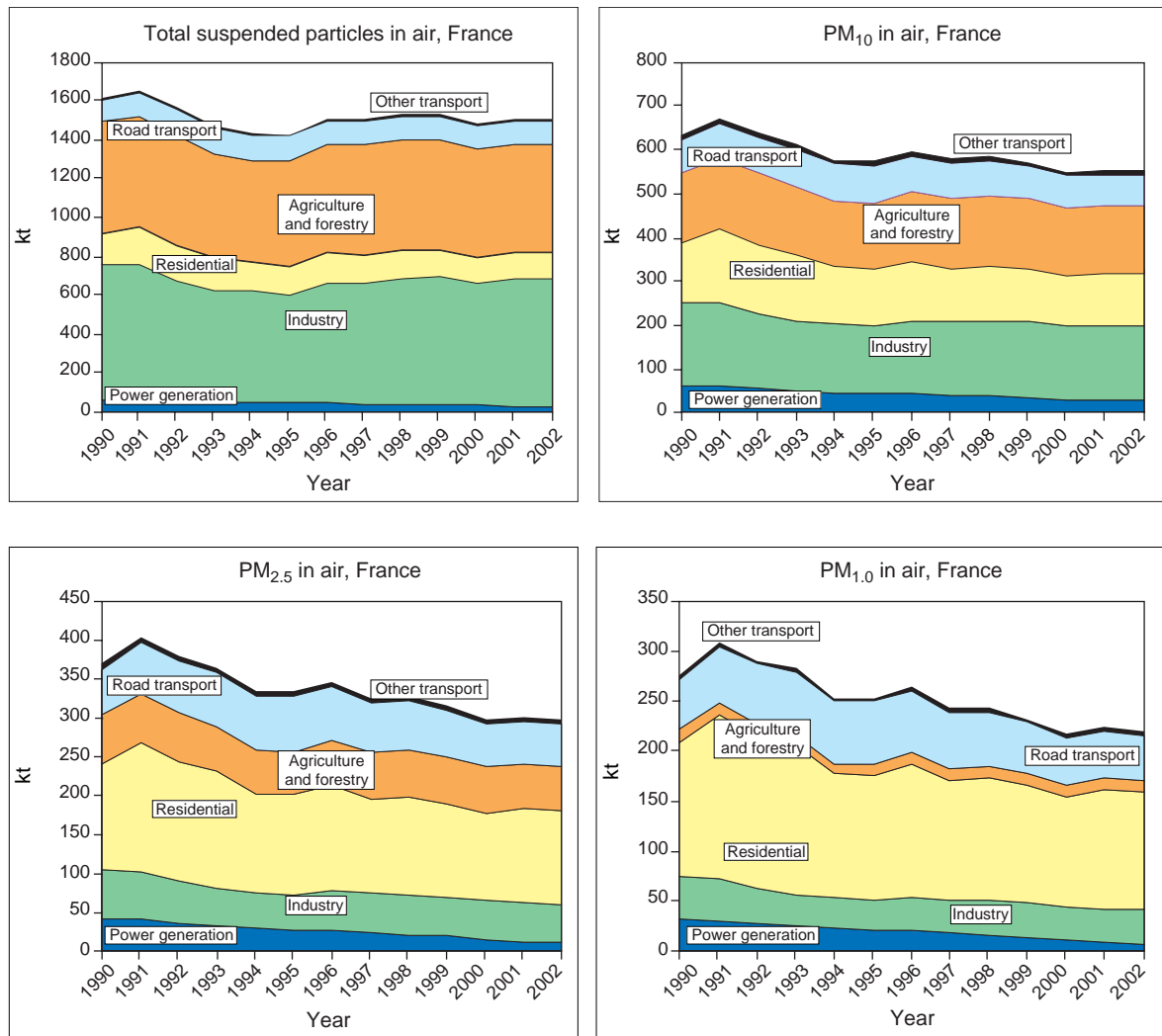

Figure 1

Sources of total suspended particles, PM₁₀, PM_{2.5} and PM_{1.0} in France [1].

1 PARTICLES: DEFINITION, SOURCES, EFFECTS AND PROPERTIES

1.1 Particles and Particulates

The term “particle” designates generally aerosols of solids and liquids and covers a large range of terms such as dust, soot, mist, fog, etc.

These particles are generated by numerous physical and chemical processes (condensation of vapours, combustion, etc.).

“Particulates” are more specifically linked to vehicle emissions. By definition, “particulates” are all the materials sampled on a fiberglass filter during a vehicle regulation test.

1.2 Particle Sources

Tiny airborne particles or aerosols that are less than 100 μm are collectively referred to as total suspended particles (TSP). These particles constantly enter the atmosphere from many sources, natural (soil, mould, pollen, salt, bacteria, etc.) or human (combustion products from heating, industrial processes, power generation, and motor vehicle use).

According to CITEPA (*Centre interprofessionnel technique d'études de la pollution atmosphérique*) [1], the part of road transport in TSP in France was around 8% in 2002, which represents more than hundred kilotons per year. Contribution of road transport in particle emissions increases as the size of particles decreases (2002 values for France):

- PM₁₀ (Particulates Matter below 10 μm of diameter): 12.6%;
- PM_{2.5} (below 2.5 μm): 17.7%;
- PM₁ (below 1 μm): 23%.

The Figure 1 shows the contribution of the different anthropogenic sources and the global emissions in France since 1990 of TSP, PM₁₀, PM_{2.5} and PM_{1.0}.

1.3 Mechanisms of Deposition in the Human Respiratory System

Particles are inhaled with the inspired air and are transported through the extrathoracic airways and the tracheobronchiolar system to the gas-exchanging region of the lung. A part of these particles may stay in the respiratory system but the deposited proportion varies with particle diameter as shown in Figure 2 [2]. The fraction of ultra-small particle (below 0.1 μm) staying in the respiratory system reaches almost 100%. Moreover, these ultra-fine particles may stay mainly in the alveolar area where gas exchanges occur.

The way the particles deposit in the respiratory system depends on their size and of the lung area. Sedimentation is due to gravity and mainly concerns particles larger than 0.5 μm . The longer is the residence time (low air flow in

small conducting airways and in the gas-exchanging area), the higher is the particle deposition by sedimentation.

Impaction is due to inertia, which depends not only on the particle size and weight but also on the flow velocity. This phenomenon, which is favoured by high flow velocities and rapid changes in airflow direction, occurs consequently mainly in the extrathoracic area and in large conducting airways of the lung.

Diffusion is a very small displacement of a particle due to its collision with gas molecules. Fine particles are more concerned than large ones by this phenomenon. The deposition of particle by diffusion is favoured by a low air flow and small distance to travel and consequently occurs mainly in the lung periphery.

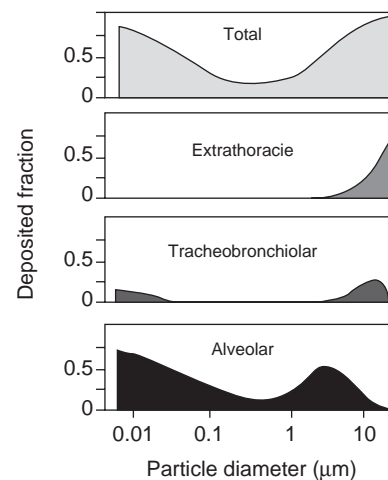

Figure 2

Deposition fraction of particle in the human respiratory system during mouth breathing.

1.4 Effects

1.4.1 Health Effects

Even if over 99% of inhaled particulate matter is either exhaled or trapped in the upper areas of the respiratory system and expelled, some of the smallest particles lodge in the lung capillaries and alveoli, causing the health effects.

Diesel exhaust particulates have a lot of known or suspected effects on human health. They induce eye, nose and airway irritations [3, 4]. Moreover, epidemiological and experimental studies have shown relations between Diesel exhaust exposure and lung cancer. For that reason, several organisations have classified diesel exhaust gas as “potential”,

“likely”, “probable” or “definite” carcinogen for human (*National Institute for Occupational Safety and Health, NIOSH* [5], *International Agency for Research on Cancer, IARC* [6], *Health Effects Institute, HEI* [7] or *US Environmental Protection Agency, US EPA* [8]). At last, Diesel exhaust particulates are suspected to have effects or have proved effects on allergic immune response, on cardiovascular system and on the reproduction system [9-16].

Recent research results indicate that very small particulates show a considerable risk for human health. This is mainly due to the presence in their composition of adsorbed PAH (Polycyclic Aromatic Hydrocarbons) known to have mutagenic or carcinogenic activity, to their content of sulphates and metals and to a general effect of particles, which mechanically overload the lungs. A lot of scientists agreed today on the fact that fine particles (PM_{2.5}) are responsible each year of thousand of deaths in Europe. Moreover, there is more and more evidence that the surface area of particles is linked to their effect on human health and especially on lung diseases [17, 18].

Particle health effect is the main reason why particle emissions are regulated for Diesel vehicles and also their maximum admitted level decreases regularly.

1.4.2 Materials/Vegetative Damage and Other Effects

In addition to human health effects, particulate matter can also affect materials and plants and also the solar radiation. Due to their physical, chemical and optical properties, particulates can corrode metals and concrete structures. They also soil building walls and windows, which induces high costs for

cleaning. Deposit of particulates on the leaf surface of plants has an effect on their growth. As very small particles remain suspended in the air for long periods of time, they can scatter light and affect also plant growth and potentially the weather.

1.5 Particulate Characteristics

If the relationship between particulates, pollution and health effects has been demonstrated through numerous epidemiological studies (§ 1.4.1), the exact biological causes of the observed effects appear often unclear. Their mass, size, reactive surface area, their chemical composition are important properties which certainly have an impact, alone or in combination.

1.5.1 Mass Emission

The particulate mass emissions, which are the only regulated values regarding particulates, are a key parameter. One can imagine that reducing mass emissions contributes to reduce the particulate impact on human health and their other effects. The following table and figures (*Table 1, Fig. 3 and Fig. 4*) indicate how in France the TSP emissions stayed quasi stable since 1990 even if the number of Diesel vehicles and the Diesel fuel consumption highly increased, which shows the impact of regulations.

1.5.2 Size

The mass emission is not the only parameter linked to the particulate effect on human health. As it has been previously

TABLE 1
Variation of suspended particle emissions, Diesel vehicles and Diesel fuel consumption in France

Year	Suspended particle emissions ⁽¹⁾				Vehicles (in thousands) ⁽²⁾		Consumption ⁽³⁾
	TSP (kt)	PM ₁₀ (kt)	PM _{2.5} (kt)	PM _{1.0} (kt)	Diesel passenger car	Low and heavy duty	Diesel fuel (thousand of tons)
1990	113	73	59	57	3265		17461
1991	121	80	64	56			18729
1992	127	84	68	60			19824
1993	129	87	71	62			20711
1994	129	86	70	61			21735
1995	129	86	70	61	6306		22869
1996	129	85	69	60	6938		23489
1997	126	81	65	57	7470		24566
1998	125	79	63	54	8540	4035	25667
1999	122	75	59	51	9180	4202	26667
2000	118	71	55	47	9775	4402	27355
2001	119	70	55	47	10696	4607	28684
2002	119	69	53	45	11668	4758	29670

1 CITEPA.

2 Comité des constructeurs français d'automobiles (CCFA).

3 Comité professionnel du pétrole (CPDP).

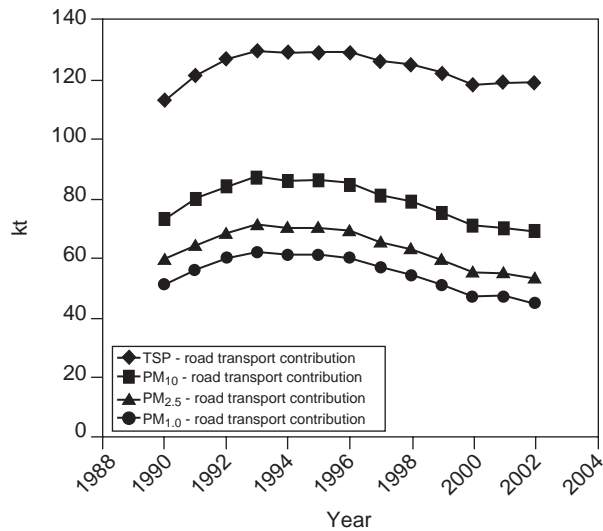

Figure 3

Evolution of road transport contribution to suspended particle emissions in France.

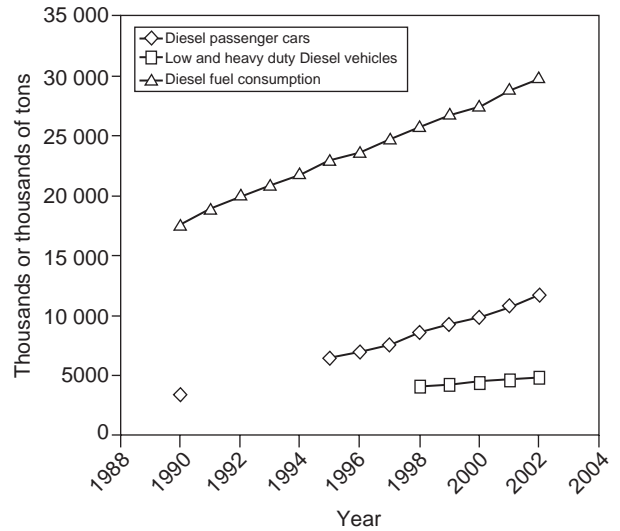

Figure 4

Evolution of Diesel vehicle number and Diesel fuel consumption in France.

explained, the particle size has an impact on the deposition mechanism into lungs. The smaller is their size, the deeper the particles may penetrate and stay in the respiratory system. Moreover, ultra-fine particles have also large surface area and therefore a greater capacity to carry toxic substances and free radicals. The size distribution appears consequently to be also an important parameter regarding particles. Furthermore, the smaller the particle size, the lower the weight. So a decrease in particulate mass emissions is not directly correlated to a decrease of ultrafine particulate emissions. Moreover, exhaust after-treatment systems may act on the particulate size distribution.

1.5.3 Chemical Composition

Diesel exhaust particulate is a complex structure of carbon onto which thousands of organic and inorganic compounds are adsorbed or deposited. Inorganic constituents are sulphate, nitrate and other chemical elements (metals or non-metals) whereas organic compounds are mainly Polycyclic Aromatic Hydrocarbons (PAH). These PAH are, for some of them, suspected to be carcinogen by several organisations such as US-EPA and IARC and by European Union as indicated in Table 2. Regarding inorganic compounds, transition metals such as iron, zinc, copper, nickel, platinum for example that may be found in Diesel exhaust particulates due to engine wear, fuel, lubricant and catalyst, may have a role in the immunotoxicity of particulates [19].

Furthermore, the knowledge of the precise and complete composition of particulates is of first importance to try to find the relationship between fuel or lubricant composition and

particulates formation. Knowing, for instance, the fuel components that are the main particulate precursors may help to formulate cleaner fuels.

Diesel exhaust particulates are limited by legislation only regarding their mass emissions. However, their other characteristics such as size and chemical composition are of primary importance, not only for professionals of health or those of environment but also for the car manufacturers and for the petroleum companies to produce cleaner vehicles and cleaner fuels. Moreover, measuring tools allow today to obtain combination of particle size distribution and composition which may bring more complete data to the researcher of all these sectors.

2 METHODS AND SYSTEMS TO ANALYSE PARTICULATES

A lot of different methods and systems exist to measure and analyse Diesel exhaust particulate mass, size and composition. In the following paragraphs are briefly described the most commonly used ones.

2.1 Mass Emissions

Current legislation in European Union [20] defines all the measurement protocols of vehicle pollutant emissions and especially of particulate matter. A Constant Volume Sampling (CVS) system should be used for the dilution of exhaust gases by air before the sampling of gases or particulates. The CVS system achieves a constant flow of diluted exhaust

TABLE 2
PAH carcinogenicity

PAH	European Union (EU)	US-Environmental Protection Agency (US-EPA)	International Agency for Research on Cancer (IARC)
Acenaphthene	–	–	–
Acenaphthylene	–	Not classifiable (D)	–
Anthracene	–	Not classifiable (D)	Not classifiable (3)
Benzo(a)anthracene	–	Probably carcinogen (B2)	Probably carcinogen (2A)
Benzo(a)pyrene	–	Probably carcinogen (B2)	Probably carcinogen (2A)
Benzo(b)fluoranthene	Probably carcinogen (cat. 2)	Probably carcinogen (B2)	Possibly carcinogen (2B)
Benzo(g,h,i)perylene	–	Not classifiable (D)	Not classifiable (3)
Benzo(k)fluoranthene	Probably carcinogen (cat. 2)	Probably carcinogen (B2)	Possibly carcinogen (2B)
Benzo(j)fluoranthene	–	–	Possibly carcinogen (2B)
Chrysene	Probably carcinogen (cat. 2)	Probably carcinogen (B2)	Not classifiable (3)
Dibenzo(a,h)anthracene	Probably carcinogen (cat. 2)	Probably carcinogen (B2)	Probably carcinogen (2A)
Fluoranthene	–	Not classifiable (D)	Not classifiable (3)
Fluorene	–	Not classifiable (D)	Not classifiable (3)
Indeno(1,2,3-c,d)pyrene	Probably carcinogen (cat. 2)	Probably carcinogen (B2)	Possibly carcinogen (2B)
Phenanthrene	–	Not classifiable (D)	Not classifiable (3)
Pyrene	–	Not classifiable (D)	Not classifiable (3)

2A and B2: the agent is probably carcinogen to humans.

2B: the agent is possibly carcinogen to humans.

3 and D: the agent is not classifiable as to its carcinogenicity to humans.

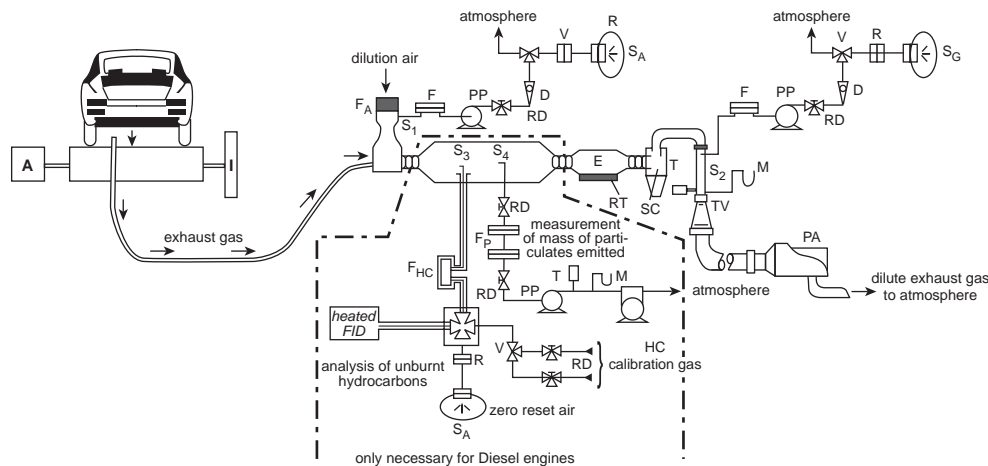

CFV/ CVS system (critical flow Venturi tube): spark engine and Diesel engine

A	power absorption system	PP	sampling pump
D	flow meter	R	quick-lock fitting
E	heat exchanger	RD	flow controller
F	filter	RT	temperature controller
F _A	dilution air filter	S ₁ to S ₄	sampling probes
F _{HC}	heated filter on hydrocarbon analysis circuit	S _A	dilution air collecting bag
F _P	measurement filters for mass of particulates emitted	S _G	dilute exhaust gas collecting bag
I	flywheel	SC	cyclone separator
M	pressure gauge	T	temperature sensor
PA	suction pump for dilute exhaust gas mixture	TV	Venturi tube
		V	quick-action valve

Figure 5

The CVS system [21].

gases even when the tailpipe exhaust flow varies (Fig. 5). Particulates are sampled from the dilution tunnel with a probe installed at a sufficient distance downstream the dilution air/exhaust gases mixing point. The sampling flow, which is maintained proportional to the total flow, is passed through a specific filter (Heat resistant borosilicate glass fiber coated with fluorocarbon (TFE)). The total mass of particulates emitted is calculated by weighting this filter before and after the sampling, and knowing the total raw exhaust gas flow passed through it. The particulate matter quantity is expressed in g/km (test of a vehicle) or in g/kW.h (engine test or heavy-duty).

2.2 Particulate Structure

The particulate geometrical structure can be obtained by electronic microscopy: the particles are sampled on Teflon filters and snapshots are taken. The Figure 6 presents an example of such a structure.

This figure shows that engine particulates are composed by spherical “unit” particles, with a diameter around 20 to 40 nm. The final particulate is then formed by the agglomeration of these unit particles.

This method allows to get information on particle formation, but remains limited for the study of particle global shape. Indeed, the accumulation of multiples particles on the sampling filter induces a forced coagulation, and consequently a modification of the particle global shape.

2.3 Number of Particles and Size Distributions

A lot of instruments are available for the measurement of total number of particles and their size distribution (Fig. 7). They are based on different physical principles and consequently, could give slightly different results.

2.3.1 Condensation Particle Counter (CPC)

A condensation particle counter measures the total number of particles in a gas. It can detect and measure ultra low concentrations of fine particles (count mode). These particles are exposed to saturated vapors of butanol and when the gas is cooled down, the vapors condense on the particles and the particles sizes grow to optically detectable values (Fig. 8). High concentrations can be determined by measuring the light extinction through the gas (photometric mode).

2.3.2 Scanning Mobility Particle Size (SMPS)

The SMPS measurement principle is based on the movement of electrically charged particles when placed in a high voltage electric field. Using this principle, it is possible to transform the initial polydisperse aerosol in a monodisperse

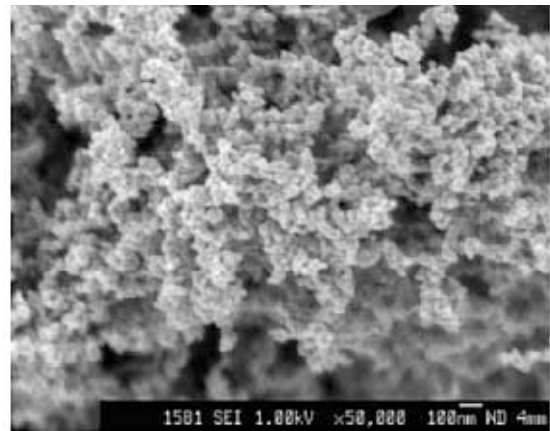

Figure 6

Electronic microscopy snapshot of Diesel particle.

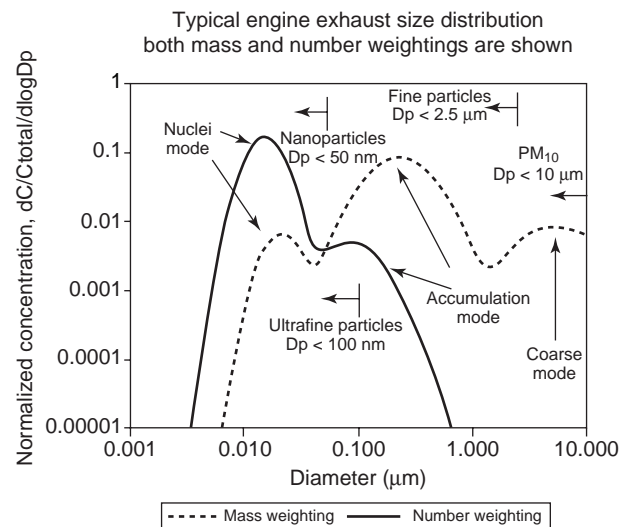

Figure 7

Typical mass and number engine exhaust size distribution [22].

aerosol of a known size. This is done by the Differential Mobility Analyser (DMA, Fig. 9). After the aerosol passed through a bipolar charge equilibrators consisting of ^{85}Kr radioactive source, this DMA acts as a filter to select out particles with a range of electrical mobilities. Then, the monodisperse aerosol goes to a CPC and the particles of this specific electrical mobility are counted. By variation of the electric field, it can be possible to scan the whole range of Diesel exhaust particle size from below 10 nm to 1 μm .

This system, because of the scanning principle, needs several seconds for measuring and, consequently, is not convenient for transient measurements. In that case, it is

possible to fix the electrical field to a given value (*i.e.* a given electrical mobility diameter) and the instrument follows continuously the variation of emission of this size of particles.

2.3.3 Impactors

Impactors select the particles according to their aerodynamic diameter, defined as the diameter of a sphere with a density of 1 g/cm^3 that has the same velocity. It consists of a series of nozzles beneath which is placed at a given distance an impaction plate. After the gas flow passes through the nozzle, it is deflected through 90° . High inertia particles do not follow the streamlines and impact on the plate whereas low inertia particles follow the streamlines and miss the impaction plate (*Fig. 10*). A cascade impactor consists of several impactor stages in series with different aerodynamic characteristics. Two ways of measurements are possible: mass size distribution (*i.e.* Low Pressure Impactor (LPI)) and number size distribution (*i.e.* Electrical Low Pressure Impactor (ELPI)). In the first case, by using collection substrates on each plate and weighting them before and after the sampling, mass size distribution can be determined. Moreover, substrates may be analysed to determine the chemical composition of the mass collected on each stage. In the second case, particles are electrostatically charged before being classified in a cascade impactor, which is operated at low pressure (allowing classification of ultra small particles). The electrical current measured on each plate is proportional to the number of particles collected, which gives the size distribution. The ELPI system (*Dekati Ltd*) measure size distribution in the range from 0.03 to $10 \mu\text{m}$ of aerodynamic diameter.

2.4 Specific Surface Area

Specific surface area can be measured using a diffusion charger. In a diffusion charger, ions are produced in the carrier gas by a corona discharge. The ions attach to the surface of the particles which are collected in an electrically insulated particle filter. The electric charge is converted to a DC voltage signal in an electrometer amplifier whose resolution is of the order of 1 fA . The DC measures the integral attachment cross section of ions. As a sticking coefficient of one can be assumed for ions, this equals the collision cross section or collision frequency. If the concentration is kept low enough to avoid multiple charging, the collision frequency for ions and neutral atoms is equal, if the particle size is larger than about 10 nm . The diffusion charger response is related to an integral value of particle diameter which is called the Fuchs area (in mm^2/cm^3) [23].

2.5 Chemical Analysis

2.5.1 Soluble/Insoluble/Volatile Organic Fractions

The first “chemical” analysis on particle emissions is the evaluation of the soluble (or volatile)/insoluble organic fractions.

The Soluble Organic Fraction (SOF) is the proportion of particles that is soluble in a solvent like the most commonly used dichloromethane. Filters containing the particles are introduced in a Soxhlet extractor (or an Accelerated Solvent Extractor, ASE). The comparison of the filter weight, before and after the extraction gives the proportion of SOF in

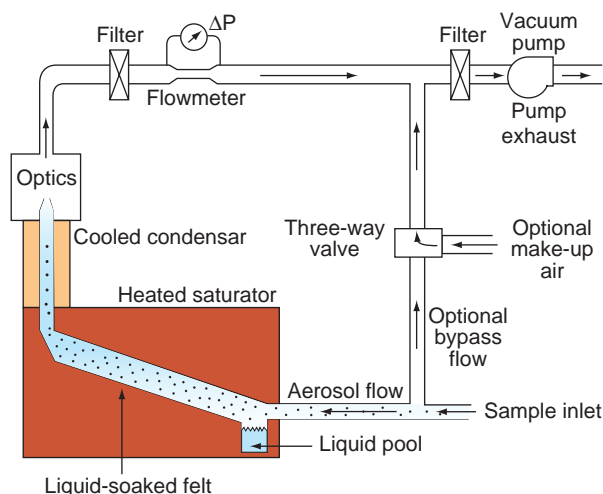

Figure 8
Condensation particle counter, principle.

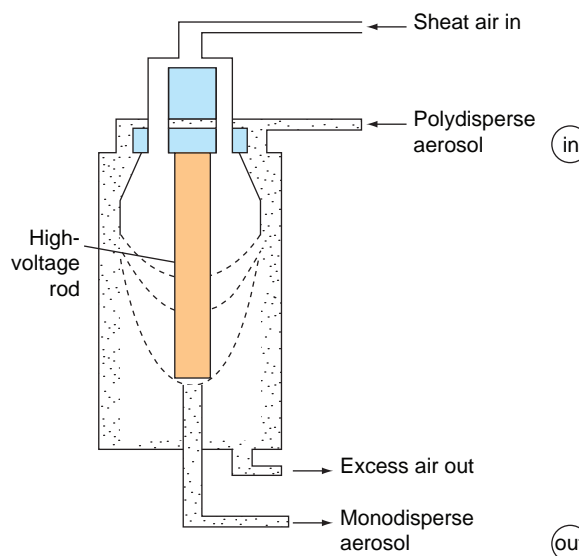

Figure 9
Differential mobility analyser, principle.

particles. By difference, the proportion of material staying on the filter is called the Insoluble Organic fraction (IOF).

When no specific analysis is required on SOF, it may be easier to determine the volatile organic fraction (VOF) and non-volatile organic fraction (NVOF) of particulates by submitting the filter to a temperature of 210°C during 3 h. Several studies showed that VOF and SOF are in general well correlated.

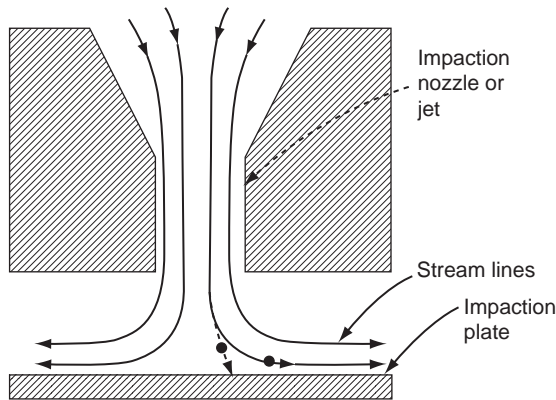

Figure 10
Inertial impactor principle.

2.5.2 PAH

As explained in Paragraph 1.4.1, PAH and their derivatives (nitro-PAH, etc.) are a group of toxic compounds generally generated by incomplete combustion of organic materials. Combustion in engine is one of the different sources of PAH emission. Some of these compounds, suspected to be carcinogen, have to be identified and accurately quantified. PAHs are one of the five toxic compounds listed by *Environmental Protection Agency of United States (EPA)*.

Particulate emissions are generally sampled on Tefloned fiberglass filter (CVS or other sampling systems). Then, an extraction phase is carried out using for example an ASE apparatus which allows rapid and efficient extractions of particulates by using solvents at high temperature [24]. The extract, after several operation of reconcentration, is analysed by a Gas Chromatography/Mass Spectrometry system (GC/MS).

2.5.3 Sulphates and Nitrates

Particulate sulphates are extracted from the filter used for particulate weight determination. The sulphates are extracted using a solution of propan-2-ol and an ultrasonic bath. The

extract is analysed by ionic chromatography. If necessary (in case of extraction by solvent for SOF analysis), the filter is first treated with ammonia to form ammonium sulphate $(\text{NH}_4)_2\text{SO}_4$.

2.5.4 Elements

Several systems and methods are available to measure the chemical element content of particulates and among them, the Particle Induced X-Ray Emission (PIXE) [25]. PIXE was first introduced at the *Lund Institute of Technology* in 1970. It is a relatively simple, powerful analytical technique that can be used to identify and quantify trace elements in a sample. Samples are irradiated by 2-3 MeV proton beam of a Van de Graaff (or other kind of) accelerator. Protons interact with the electrons in the atoms of the sample, creating inner (K and L) shell vacancies. When the vacancies are refilled with electrons from higher shells, X-rays are emitted. Energy of X-rays are characteristic of the element from which they originate, and the number of X-rays is proportional to the amount of the corresponding element within the sample. X-ray detection is usually done by Si(Li) energy dispersive semiconductor detectors. The substrates used to collect particulates must not perturb the analysed signal by too high traces of minerals.

This method is a surface analysis, and the concentration is given in $\mu\text{g}/\text{cm}^2$. It is consequently important to have a uniform repartition of the particulates on the sampling filter. This is generally the case for “classical” samplings, but the conception of the particle impactor leads to non-uniform deposits. In that case, the particulates are deposited in more or less complex geometrical shapes. In order to lower the impact of this parameter on the analysis quality, some parameters have been modified in the sampling and in the analysis processes:

- Polycarbonate filters are used instead of Teflon filters. These latest have a too high metal content, inducing pollution of the samples. Moreover, polycarbonate filters allow a decrease of perturbing phenomenon such as radiation absorption.
- Sampling time is decreased, to optimise the compromise “sample thickness (as low as possible)/quantification limit”.
- A 15 mm diameter diaphragm is used to perform the analysis on the entire filter.
- The radiation intensity is increased to get analysis in the core of the sample and not only on the surface.

2.6 Combination of Measurements

The different analytical techniques can be combined for example:

- to better understand the mechanism of formation of particulates;
- to evaluate more deeply their toxicity;

- to find correlation between particulate chemical composition and fuel and lubricant composition;
- to better assess the impact of engine or after-treatment system technologies on particulate emissions;
- etc.

For example, the combination of LPI measurement and PAH analysis of filters gives the precise PAH size distribution which is of a great concern for human health.

Moreover, combination of mass size distribution (LPI) and number size distribution may add useful information to the study.

The following chapter illustrates through some examples such combinations.

3 DETAILED CHARACTERISATIONS OF PARTICULATE EMISSIONS COUPLING THESE TECHNIQUES

All the analysis described above allow to obtain a comprehensive description of particles mass, number, size, specific surface and chemical composition. Nevertheless, this vision remains global and only gives a “mean” value. In order to obtain further information on the particles, to explain their formation mechanisms or to better analyse their effects, it appears interesting to couple these different analytical techniques. Thus, it becomes possible to obtain data on particle density, shape, specific composition and on formation or deposition mechanisms of chemical compounds.

3.1 Particle Density

The study of the particle density can give valuable data on the internal structure of the particles, and even on their formation. Two methods can be used: gravimetric measurements using ELPI (Electric Low Pressure Impactor) or calculations from SMPS and ELPI measurement results.

3.1.1 Gravimetric Measurements Using ELPI

After a classification of the particles according to their aerodynamic diameter, the particles can be counted electrically and sampled on a filter. This filter is then weighted. The comparison of these 2 measurements allow to calculate a density of the particles according to their diameter.

The main advantage of this technique is that it can be led with one single apparatus: the ELPI, which can separate and sample particles on filters according to their aerodynamic diameter, but also counts the number of particles on each sampling filter.

Nevertheless, this technique remains difficult to use, mainly due to the very low emission level of modern vehicles. With emissions lower than 5 mg/km (Diesel vehicles equipped with Diesel Particulate Filter-DPF), the

sampling on 13 different filters leads to very low masses on each filter.

Moreover, the mass of the particles is proportional to the cube of the diameter, and consequently the most important mass is found on the high diameter sampling plates. For the lowest cut-off diameter (< 100 nm) impaction plates, the mass of particle collected is often below the quantification limit.

3.1.2 Calculation

The second method to assess particle density is based on the comparison between two techniques used for particle size measurements: SMPS and ELPI. These techniques have been previously described in this paper.

As explained in Paragraphs 2.3.2 and 2.3.3, each measurement technique measure different diameters (aerodynamic or mobility diameter), which are in fact “equivalent diameters”, corresponding to equivalent particles, with the same final velocity obtained in a given force field:

- for the SMPS, the force field is an electric field. The diameter studied is called “electrical mobility diameter” and is defined as the diameter of a solid sphere with the same density and final velocity than the real particle;
- for the ELPI, the force field is an aerodynamic drag force field. The measured diameter is called “aerodynamic diameter” and is defined as the diameter of a solid sphere with a unit density and the same final velocity than the real particle.

The two diameters can be linked with a semi-empirical law:

$$D_a^2 \cdot C(D_a) \cdot \rho_0 = D_b^2 \cdot C(D_b) \cdot \rho_{\text{eff}} \quad (1)$$

with $C(D_i)$: Cunningham Slip correction factor (empirical law) and ρ_{eff} : effective density of the particle.

This link between the two diameters allow to calculate a particle density according to the diameter and consequently to have information on the density and even composition of the particles.

The Figure 11 shows that the calculated density presents a quite interesting profile:

- for the very small particles (20-30 nm), the calculated density is around 1 g/cm³;
- for particle with higher diameter, the density first increases linearly to approximately 2 g/cm³ for 70 nm and then decreases to 1.3 g/cm³.

The commonly accepted value for carbon density is around 2 g/cm³ [26]. The shape of the curve consequently shows that the nucleation aerosol (< 30 nm) and agglomeration particles (carbonaceous fractions, > 30 nm) have a radically different chemical composition. The density of carbonaceous particles decreases with the size, due to the increase in agglomerate particle porosity. It has been previously shown

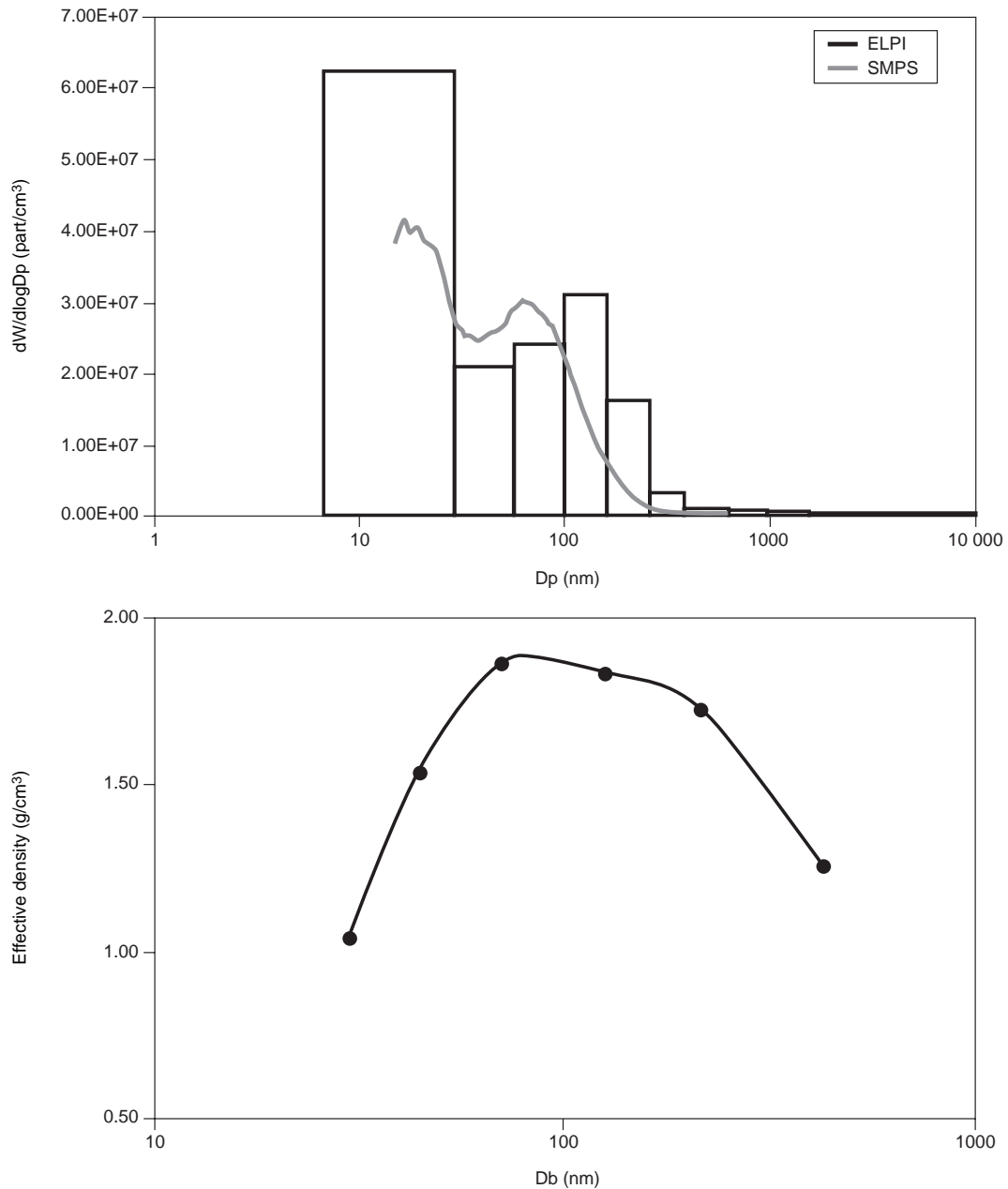

Figure 11

Calculation of particle effective density, particle emissions (top) and calculated density (bottom).

(Section 2.2) that diesel particles are composed by the agglomeration of spherical particles, with a diameter around 20-40 nm. The high density of particles with diameter between 50 nm and 110 nm (around 2 g/cm³), which are agglomerate of few single particles, shows that their structure is close to the one found in carbon black.

The low calculated density of particulates below 40 nm is certainly due to the presence of sulphates which form a nucleation aerosol containing water.

3.2 Particle Shape

3.2.1 Theory

As described above, the measurement of the real size of the particles remains difficult. Indeed, these particles are an agglomeration of multiple spherical particles. The arrangement of these particles plays an important role in the global shape of the agglomerates and consequently on their impact on health (different penetrations in the respiratory tracks).

To evaluate the shape of the particles, it is possible to use electronic microscopy techniques (*Section 2.2*) but this requires a sampling on filters and consequently, this could modify the shape of the particles by a forced agglomeration.

The most commonly used method to get information about the particles shape is to measure the active surface. For a given diameter, a compact particle with low porosity will give a low surface, while an agglomerate with high porosity will give a high surface.

The active surface is measured with a “diffusion-charger” (*Section 2.4*).

It can be shown that for a certain particle mobility b , mobility and active surface A are inversely proportional within an uncertainty of some percent independently of particle size, shape or material [27].

$$b \cdot A = \text{const.} \quad (2)$$

An example of the use of this analysis is described hereafter.

3.2.2 Example of Results

Vehicles equipped with DPF (Diesel Particulate Filter) present sometimes higher emissions (in number of particles) than “traditional” diesel vehicles, due to the nucleation phenomenon.

With the help of particle density evaluation, it has previously been shown that the structure of this aerosol is radically different than typical diesel soot (lower density).

Some measurements have been performed with the use of SMPS and DC (Diffusion charger). The SMPS allows to get the particle diameter distribution and consequently to

calculate a surface, with the assumption that the particles are spherical. The comparison of this calculated surface and the measured specific surface gives important information about the shape of these aerosols.

As shown in the Figure 12, the correlation between calculated and measured surface is good for the vehicle equipped with DPF. On the other side, the calculated surface for the vehicle not equipped with DPF is lower than the measured surface. These results show that the aerosol detected at the exhaust of the vehicle equipped with DPF is composed of spherical particles, while the aerosol at the exhaust of non-filtered vehicle is not composed of spherical particles, or has a high porosity.

Through this result, it can be assumed that nucleation aerosols are constituted of spheres which are probably liquid droplets.

3.3 Chemical Analysis

3.3.1 Sampling

The chemical analysis of particulates according to their size is an interesting tool to try to understand the formation mechanisms.

The particulate sampling is performed using a low pressure impactor and Teflon fiber-coated filters. In order to allow chemical analysis, the filters are used bare, without any grease. Particulates collected in the impactor plates are weighted to determine the size distribution. The samples can then be chemically analysed.

This technique consequently allows to obtain the chemical composition of the particulates on each impaction plate, and consequently up to 13 ranges of diameters. Nevertheless, some issues have to be taken into account:

- As the gas sample is drawn through the instrument by a vacuum pump, particle losses through evaporation of volatile material may occur in the low pressure stages. Most of the time, the minimum pressure is around 100 mbar. If the gas temperature is stabilised around 30°C in the impactor, it can be assumed that all the volatile compounds with a boiling point lower than 100°C are vaporised.
- For vehicles with low particulate emission levels, the sampling on multiple plates induces very low masses on each plate and consequently requires to use very long sampling times. For typical diesel vehicles (common-rail, without DPF), 3 to 4 h sampling are commonly used. The difficulty is then to avoid any shift in the engine or vehicle running point.
- The use of Teflon filters can induce “bouncing” phenomena: some particles can hit the sampling surface but don’t remain stuck on it. Dragged by their inertia, they can bounce and be rejected on the following sampling plate. The particle size repartition is then moved toward low

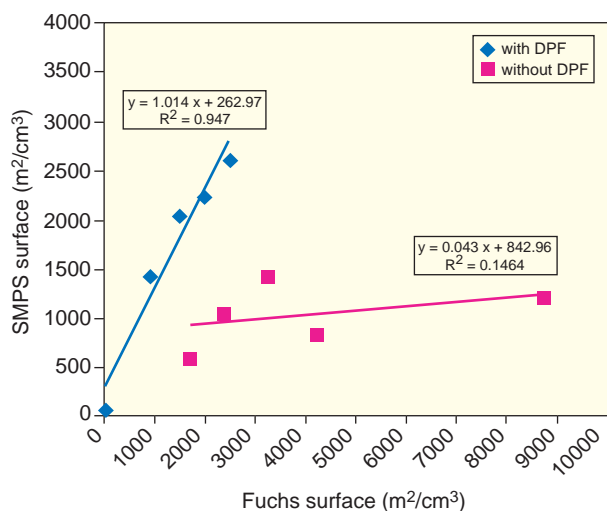

Figure 12

Comparison of measured and calculated surfaces.

sizes. In order to avoid this phenomena, the most efficient solution is to use grease-sintered aluminium filters in order to “stick” the particles on the impaction plate. But, this technique is not compatible with chemical analysis. But, it has been shown that, considering that the sampled mass remains low (approximately less than 1 mg/filter), the bouncing phenomenon can be neglected. As the mass repartition is not the same for all the impaction plates, the sampling time has to be set in order to obtain less than 1 mg on the most loaded filter, often inducing very low mass on the “extreme” impaction plates (small and large diameters).

As underlined above, the particulates sampling with cascade impactors remains difficult: the sampling time and dilution ratio must be carefully chosen in order to obtain the optimal mass on the filters.

An example of the mass sampled for a 2 litres Diesel engine is presented in the following Figure 13:

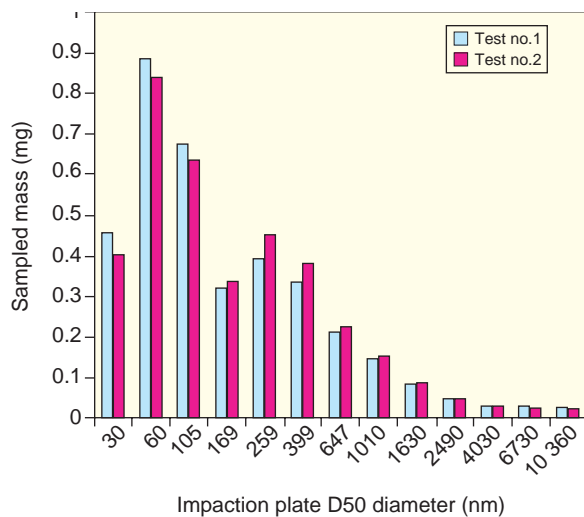

Figure 13
Particulate sampling example, Diesel engine.

3.3.2 Analysis

After having sampled the particulates according to the different cut-off diameters, the filters can be analysed with the methods described in the Section 2.5.

These analyses are:

- SOF (Soluble Organic Fraction)/IOF (Insoluble Organic Fraction) repartition;
- sulphates, nitrates;
- PAH analysis;
- elements analysis.

The following sections describe the simultaneous use of these techniques in order to get information about the internal chemical structure and formation process of Diesel particles. It focuses on element and PAH analyses. The example presented here is based on tests conducted at *IFP* on a pre-chamber Diesel vehicle with a Euro96 Diesel fuel (500 ppm sulphur). Indeed, the high particulate level allows easier sampling and chemical analysis. Nevertheless, the data analysis would be similar with a more modern diesel vehicle.

Element Analysis

The analysis of elements (metals and non-metals) in the samples is performed by PIXE (Particle Induced X-ray Emission), as described in Section 2.5.4.

The elements that are commonly measured in the particulates samples are: S, Cl, K, Ca, Cr, Mn, Fe, Ni, Cu, Zn and Sb.

Coupling this analysis and size distribution allows to get information about the origin of the elements. Two main sources can be found: engine and exhaust line wear and fuel/lubricant additives.

Metals such as iron or chrome can be found in the engine parts and can consequently be considered as “wear metals”. The Figure 14 shows that these metals present a very high concentration on the impaction plate 13 (10 μm).

On this chart, a logarithmic scale has been used. Chrome is only detected on the plate 13. Iron can be found on all the plates, but the content of the 10 μm plate (3000 ppm) is significantly higher than that of the other impaction plates (less than 200 ppm). Moreover, there is no direct correlation between particulate diameter and the iron content.

Results obtained for antimony appear very different (*Fig. 15*): a strong correlation is observed between antimony concentration and the impactor plate cut-off diameter. This seems to indicate that this metal does not come from bearing wear (Pb-Sn-Sb alloy), because in that case, antimony would have been found mainly on high diameter sampling plates. Moreover, the lack of metals such as Sn or Pb confirms that antimony doesn't come from wear. Consequently, antimony may originate from the combustion of the fuel or the lubricant themselves. Two main sources could be supposed for this metal: impact of FCC catalysts used in refinery processes or use in the fuel of an antimony-based additive (detergent additive such as DTPSb (antimony dithiophosphates)).

The relationship between antimony and sulphate contents (*Fig. 16*) indicates that their deposition mechanisms are similar. It is known that most of the sulphates are formed in the exhaust line, by an oxidation of sulphur during the agglomeration of the particles. This result tends to show that this is also the case for some metals and especially antimony. Nevertheless, most of the metals do not follow this trend (Fe, Ca, etc.). This difference can be explained by the chemical reactions in the combustion chamber. For instance,

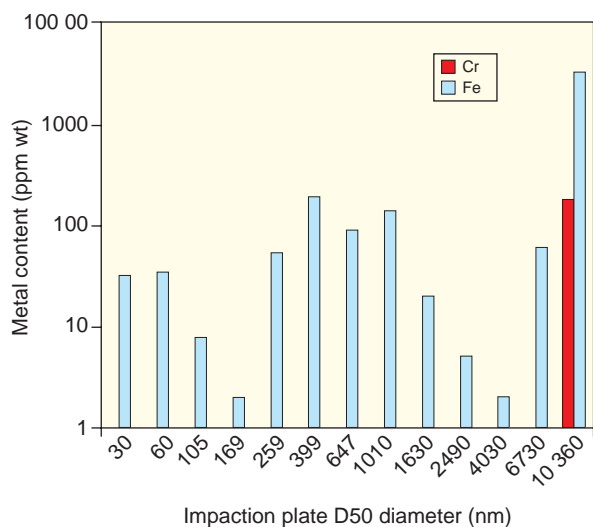

Figure 14
"Wear metals" content.

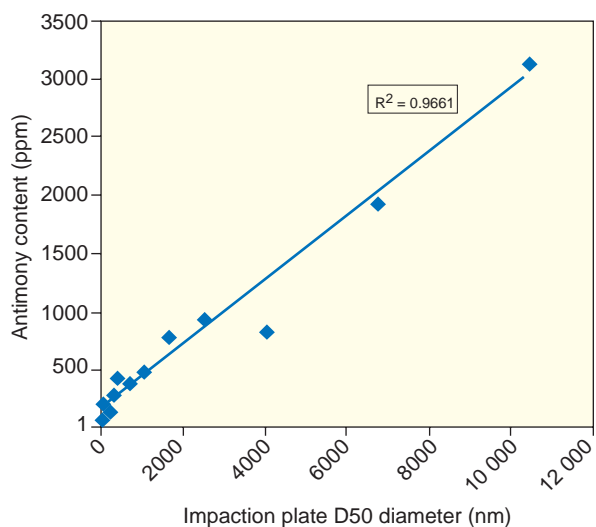

Figure 15
Sb analysis on the different impaction plates.

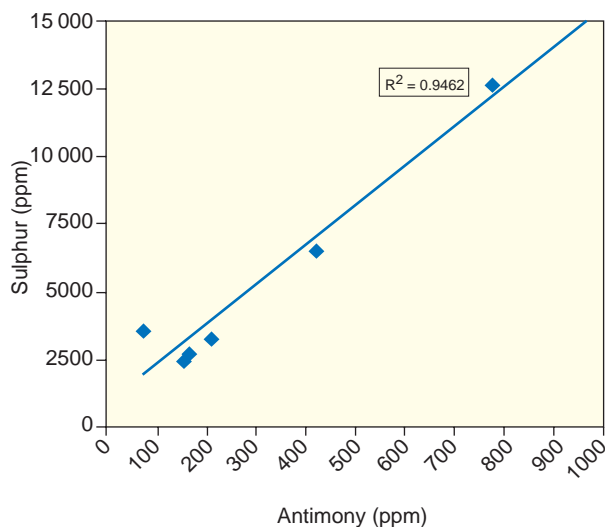

Figure 16
Correlation between sulphur and antimony concentrations.

as far as calcium is concerned, solid compounds (CaO for instance) are formed around 1700 K (above this temperature, the huge majority of the calcium is found in $\text{Ca}(\text{OH})_2$, in gaseous form). As far as antimony is concerned, some compounds such as HSbO_2 are present at relatively low temperatures (around 1000 K). These elements are deposited on the particle surface later in the combustion and cooling process.

As explained above, some elements are found exclusively on the high diameter impaction plates: Cl, K, Fe, Zn, Cr. Some of these elements come from engine wear. For instance, the presence of chrome (Cr) shows an important piston ring wear. Such a process could also explain the presence of Iron and Nickel.

Some metals, such as Zinc, Manganese, Calcium or Copper show a different behaviour: the high concentration of these metals on the high diameter impaction plate show that they are linked to the engine wear. Nevertheless, they are also present at quite high rates in the other impaction plates. This can be explained by another deposition way, during the combustion itself. These metals are also present in the fuel or lubricant (additives):

- Zn: organometallic additives, such as zinc dithiophosphates (DTPZn, detergent additive);
- Cu: this element can be found in some additives (anti-oxidant/anti-wear). Moreover, the quite high concentration of this element in the samples could be explained by a chemical corrosion of the Cu-Pb bearings due to the presence of chlorine or sulphur compounds;
- Ca: calcium is present at a quite important rate in the lubricant.

PAH Measurements

Polycyclic Aromatic Hydrocarbon (PAH) measurements can also be led on the sampling filters. In our case, 11 molecules have been detected and quantified. The following charts show the PAH repartition by particulate size.

It appears that the PAH concentration is not linked to the particle diameter (global PAH concentration of around

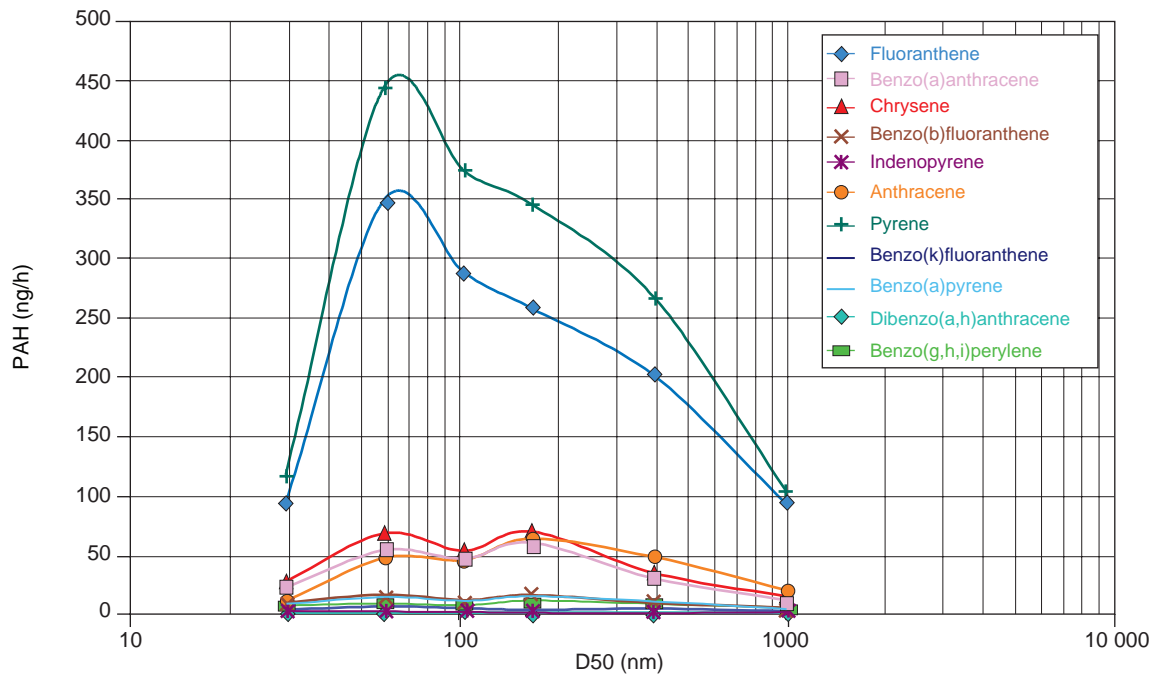
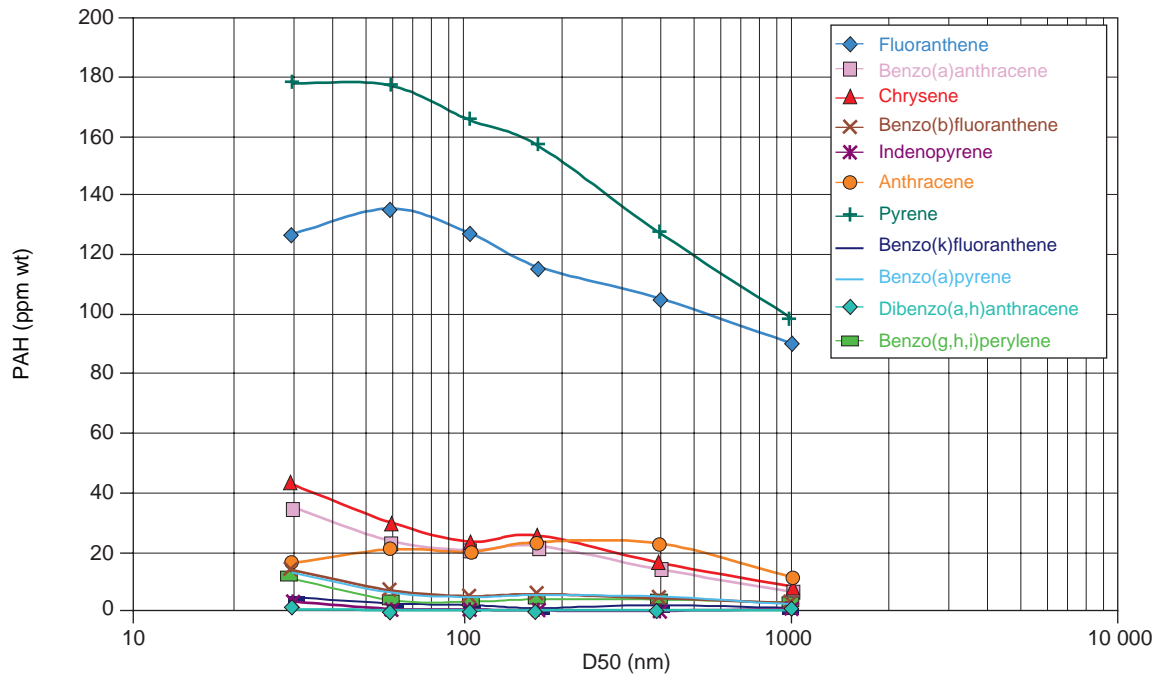

Figure 17
PAH repartition by particulate size.

400 ppm on each plate). This phenomenon has been already noticed in several previous studies [28, 29] and can be explained considering another result: the total PAH concentration on the 13 sampling plates is always 3 to 4 times lower than the concentration measured on typical sampling filters, when the particles are sampled by filtering the diluted exhaust gases. The sampled particles can in this case play the role of “absorbent” for the unburned hydrocarbons. When sampling the particles with impactors, the filter is not crossed by exhaust gases. Therefore, this method limits the impact of sampling.

Moreover, these curves show a size repartition of PAH significantly different than the one measured for sulphates and antimony. It can consequently be assessed that the formation and deposition mode of PAH is different. It has been previously said that SOF and sulphates are deposited at the end of the combustion, during the cooling phase. PAHs seem consequently to be deposited in an earlier phase, and seem to be better linked to the internal structure of particles than to the specific surface.

In Table 3, which shows both concentration and molar weight of the analysed PAH molecules, we observed that the concentration classification is well linked to the molar weight as shown in the following Figure 18.

TABLE 3
PAH measurement results

Molecule	Concentration (ppm)	Molar weight (g/mol)
Pyrene	897.5	202.0
Fluoranthene	713.5	202.0
Chrysene	144.8	228.0
Benzo(a)anthracene	120.5	228.0
Anthracene	112.9	178.0
Benzo(b)fluoranthene	37.1	252.0
Benz (a)pyrene	36.4	252.0
Benzo(g,h,i)perylene	28.4	276.0
Benzo(k)Fluoranthene	11.9	252.0
Indénopyrene	5.4	276.0
Dibenz(a,h)anthracene	0.5	278.0

This may reflect the formation mode of PAH and their role in the combustion as reaction intermediates. This is convenient with commonly admitted particle formation mechanisms (step-by-step PAH formation by acetylene addition, “HACA” mechanism).

CONCLUSIONS

Knowing not only the emitted quantities of particulates but also their detailed composition, their specific surface and their way of formation are key issues for researchers, environmentalists, car manufacturers and petroleum companies.

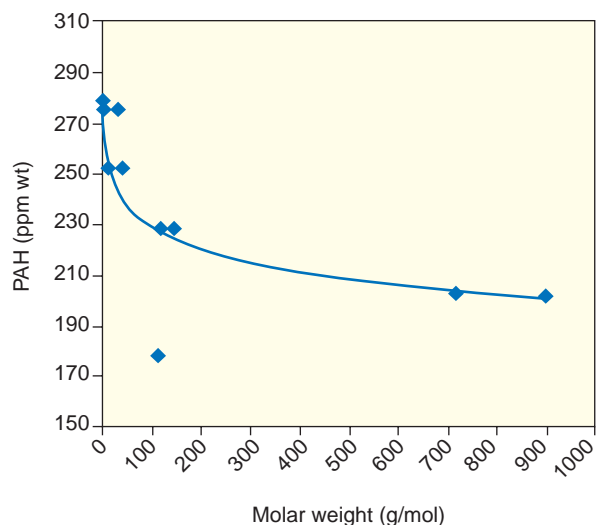

Figure 18

Correlation between PAH molar weight and emissions.

If the regulated value for particulate mass emission decreases continuously, the total suspended particles quantity in France stays quasi-stable. Moreover, the transport contribution to these TSP is larger for the ultra-fine particles.

Using various methods of sampling and analyses, it is possible to obtain important and significant information on particulate mass, size distribution or chemical composition for instance. Particulate emissions are composed by the agglomeration of small spherical “unit” particles, with a diameter around 30 nm. Some smaller size aerosol can also appear in specific conditions (dilution, etc.), but the density measurement, as well as surface measurements have shown that this aerosol is composed by liquid droplets.

Moreover, by the coupling of different techniques, such as size distribution and chemical analysis, it is possible to obtain data on the internal structure, the chemical structure, but also on their formation mode. Thus, the chemical analysis according to the size of the particles allowed to obtain precious data concerning the particles composition, showing different formation modes (deposition during the combustion or during the cooling phase) and different origins of the components (wear metals, additivation metals, etc.).

REFERENCES

- 1 CITEPA/CORALIE (2003) *Inventaire des émissions de polluants atmosphériques en France. Séries sectorielles et analyses étendues*, Format SECTEN, février.
- 2 Schulz, H. *et al.* (2000) Particle deposition in the respiratory tract. In: *Particle-Lung Interactions* (J.H. Peter Gehr, eds.), Marcel Dekker, Inc, New-York, 229-29.
- 3 Rudell, B., Ledin, M., Hammarstrom, U., Stjernberg, N., Lundback, B., and Sandstrom, T. (1996) Effects on

- symptoms and lung function in humans experimentally exposed to diesel exhaust. *Occup. Environ. Med.*, **53**, 10, 658-662.
- 4 Rudell, B., Sandstrom, T., Hammarstrom, U., Ledin, M. L., Horstedt, P., and Stjernberg, N. (1994) Evaluation of an exposure setup for studying effects of diesel exhaust in humans. *Int Arch Occup Environ Health*, **66**, 2, 77-83.
 - 5 NIOSH (1988) *Carcinogenic Effects of Exposure to Diesel Exhaust*, National Institute for Occupational Safety and Health, Centers for Disease Control, Atlanta, GA.
 - 6 IARC (1989) *Diesel and Gasoline Engine Exhaust and Some Nitroarenes*, World Health Organisation, International Agency for Research on Cancer, Lyon, France.
 - 7 HEI (1995) Diesel exhaust: a critical analysis of emissions, exposure and health effects. *Special Report of the Institute's Diesel Working Group*, Health Effects Institute, Cambridge, MA.
 - 8 US EPA (2000) *Health Assessment Document for Diesel Exhaust*, US Environmental Protection Agency, Washington DC.
 - 9 Diaz-Sanchez, D., Garcia, M.P., Wang, M., Jyrala, M., and Saxon, A. (1999) Nasal challenge with diesel exhaust particles can induce sensitization to a neoallergen in the human mucosa. *J Allergy Clin. Immunol.*, **104**, 6, 1183-1188.
 - 10 Diaz-Sanchez, D. (1997) The role of diesel exhaust particles and their associated polyaromatic hydrocarbons in the induction of allergic airway disease. *Allergy*, **52**, 38, 52-58.
 - 11 Donaldson, K., and MacNee, W. (2001) Potential mechanisms of adverse pulmonary and cardiovascular effects of particulate air pollution (PM10). *Int. J. Hyg. Environ. Health.*, **203**, 5-6, 411-415.
 - 12 Dockery, D.W. (2001) Epidemiologic evidence of cardiovascular effects of particulate air pollution. *Environ. Health Perspect.*, **109**, suppl. 4, 483-486.
 - 13 Peters, A., Dockery, D.W., Muller, J.E., and Mittleman, M.A. (2001) Increased particulate air pollution and the triggering of myocardial infarction. *Circulation*, **103**, 23, 2810-2815.
 - 14 Peters, A., and Pope, C.A., 3rd (2002) Cardiopulmonary mortality and air pollution. *Lancet* **360**, 9341, 1184-1185.
 - 15 Taneda, S., Hayashi, H., Sakata, M., Yoshino, S., Suzuki, A., Sagai, M., and Mori, Y. (2000) Anti-estrogenic activity of diesel exhaust particles. *Biological & Pharmaceutical Bulletin*, **23**, 12, 1477-1480.
 - 16 Taneda, S., Hayashi, H., Sakushima, A., Seki, K., Suzuki, A.K., Kamata, K., Sakata, M., Yoshino, S., Sagai, M., and Mori, Y. (2002) Estrogenic and anti-estrogenic activities of two types of diesel exhaust particles. *Toxicology*, **170**, 1-2, 153-161.
 - 17 Tran, C.L. et al., Inhalation of poorly soluble particles. II. Influence of particle surface area on inflammation and clearance. *Inhal. Toxicol.*, **12**, 101-115.
 - 18 Donaldson, K. (2003) Toxicology of ultrafine particles for non-toxicologist. *Presentation to the AIRNET Health Impact Assessment Working Group, 3rd Meeting*, Edinburgh, July 17-18.
 - 19 Zelikoff, J.T. et al. (2002) A role for associated transition metals in the immunotoxicity of inhaled ambient particulate matter. *Environmental Health Perspectives*, **110**, suppl. 5, Oct. 871-875.
 - 20 Directives 70/220/EEC and 98/69/EC.
 - 21 Degobert, P. (1995) *Automobile and Pollution*, Institut Français du Pétrole Publications, Éditions Technip, Paris.
 - 22 Kittelson, D, University of Minnesota, Center for Diesel Research.
 - 23 Fuchs N.A. (1964) *Mechanics of Aerosols*. Pergamon, New York.
 - 24 Pasquereau, M. and Montagne, X. (1999) Comparison between Soxlet extraction and an accelerated solvent extraction method for the determination of individual PAHs from diesel particulates. *Middle Eastern Symposium on Environmental and Sanitary Analytical Chemistry*.
 - 25 Johansson, S.A.E., Campbell, J.L. and Malmqvist, K. (1995) Particle-induced X-ray emission spectrometry (PIXE). *Chemical Analysis*, **133**, Wiley, New York.
 - 26 *CRC Handbook of Chemistry and Physics*, CRC Press.
 - 27 Filippov, A. (1993) Charging of aerosols in the transition regime. *J. Aerosol Sci.*, **24**, 423-436.
 - 28 Westerholm, R. and Christensen, A. (1999) Determination of polycyclic aromatic hydrocarbons (PAH) in size fractionated diesel particles from a light duty vehicle. *SAE Paper 1999-01-3533, 1999 Transaction of SAE Fuels & Lubricants Conference Papers*.
 - 29 Kittelson, D.B. (1988) Engines and nanoparticles: a review. *J. Aerosol Sci.*, **29**, 5/6, 575-588.

Final manuscript received in February 2005