

Interest and Applications of Multidimensional Gas Chromatography for Trace Analysis in the Petroleum Industry

F. Bertoncini, C. Vendevre, D. Thiébaud

► **To cite this version:**

F. Bertoncini, C. Vendevre, D. Thiébaud. Interest and Applications of Multidimensional Gas Chromatography for Trace Analysis in the Petroleum Industry. Oil & Gas Science and Technology - Revue d'IFP Energies nouvelles, Institut Français du Pétrole, 2005, 60 (6), pp.937-950. 10.2516/ogst:2005066 . hal-02017261

HAL Id: hal-02017261

<https://hal-ifp.archives-ouvertes.fr/hal-02017261>

Submitted on 13 Feb 2019

HAL is a multi-disciplinary open access archive for the deposit and dissemination of scientific research documents, whether they are published or not. The documents may come from teaching and research institutions in France or abroad, or from public or private research centers.

L'archive ouverte pluridisciplinaire **HAL**, est destinée au dépôt et à la diffusion de documents scientifiques de niveau recherche, publiés ou non, émanant des établissements d'enseignement et de recherche français ou étrangers, des laboratoires publics ou privés.

Interest and Applications of Multidimensional Gas Chromatography for Trace Analysis in the Petroleum Industry

F. Bertoncini¹, C. Vendeuvre¹ and D. Thiébaud²

¹ IFP-Lyon, Département Caractérisation des produits, BP 3, 69390 Vernaison - France

² Laboratoire Environnement et chimie analytique, École supérieure de chimie et de physique industrielle, 10, rue Vauquelin, 75005 Paris - France
e-mail: fabrice.bertoncini@ifp.fr - colombe.vendeuvre@ifp.fr - didier.thiébaud@espci.fr

Résumé — Intérêt et applications de la chromatographie en phase gazeuse multidimensionnelle pour l'analyse des composés à l'état de trace dans l'industrie pétrolière — L'objectif de cet article est de démontrer l'intérêt et les avantages de la chromatographie en phase gazeuse multidimensionnelle (CPG MD) pour analyser des composés présents à l'état de trace dans des matrices organiques complexes comme les mélanges d'hydrocarbures, les échantillons d'huiles ou pétroliers et les charges et effluents des procédés pétrochimiques ou de raffinage. Dans ce cas, la réussite de l'analyse de trace dépend considérablement de l'étape de séparation et, à cet égard, la chromatographie en phase gazeuse multidimensionnelle peut fournir une augmentation de la capacité de pic permettant une meilleure identification et quantification des composants à l'état de trace. Des notions générales de l'analyse de trace organique dans le domaine de l'industrie pétrolière ainsi que le principe de la CPG MD et de la chromatographie en phase gazeuse bidimensionnelle (GC-2D) sont présentés. L'instrumentation est illustrée avec une attention particulière aux derniers développements de la CPG MD. Diverses applications de la CPG MD et de la GC-2D soulignent l'apport de ces techniques d'analyses comme la détermination des traces d'oxygénés dans la coupe C₄ par CPG MD ou la quantification et la détermination de sous-produits présents à l'état de trace dans des procédés pétrochimiques comme les procédés Fischer-tropsch ou de déhydrogénation de normales paraffines.

Abstract — Interest and Applications of Multidimensional Gas Chromatography for Trace Analysis in the Petroleum Industry — This paper aims to point out the interest and the advantages of multidimensional gas chromatography (MDGC) for performing trace analysis in complex "organic" mixtures such as hydrocarbon mixtures, petroleum or oil samples, and typical feeds and products from refinery or petrochemical processes. In these cases, the success of trace analysis strongly depends on the separation step. Multidimensional gas chromatography could therefore provide an enhancement of detection capacity leading to a better identification and quantification of trace components. General notions of organic trace analysis in the field of the petroleum industry are presented as well as the principle of multidimensional gas chromatography and comprehensive gas chromatography (GC×GC). A description of typical instrumentation is given with emphasis on recent developments and improvements in MDGC. A variety of applications underlines the high interest of these techniques. Examples presented here are the determination of oxygenates in C₄ cuts by MDGC, the quantification of by-products present in trace level effluents obtained in petrochemical process such as the Fischer-Tropsch process and dehydrogenation of normal paraffins studied by comprehensive GC×GC.

INTRODUCTION

Discussion on the Signification of “Organic Trace Analysis”

The term “trace analysis” means the determination of compounds which are present in very low concentrations in pure substances, or in a mixture of substances, and which are generally referred to as trace components.

The field of trace analysis is usually characterised by defining the limits of detection but these largely depend on:

- the analytical methods available;
- the nature of the matrix in which the trace components are included;
- and the nature of the trace components themselves.

Therefore, the ranges of concentration required for trace analysis are often relative. This is the case for gas chromatographic analysis in which the separation (separation step) and determination (identification and quantification steps) of the individual components are frequently carried out in a single operation. In this case, the limit of detection is usually obtained on the basis of a calculated sensitivity of the detector, using standard compounds. However, it is known that the result of a gas chromatographic trace determination depends ultimately on many other parameters. Thus, the efficiency of the separation (and its ability to distinguish the undesirable components, *e.g.* the matrix, from trace components) and its dependence on sample size, as well as the nature and the stability of stationary phase are equally important parameters. Moreover, the composition of material, the nature and the state of the sample, the method by which it is collected can also be important. For these reasons, the so-called theoretical limits of detection, which have been determined independently on the basis of the sensitivity of the detectors employed, are not achieved in practice.

One main aspect concerning the requirement for a trace analysis is to determine the concentration level at which it is meaningful to determine the trace components. This crucial point depends strongly on the particular problem of the analyst and the process engineer.

From a general point of view in the petroleum industry, it is considered that trace analyses are necessary as soon as industrial processes may be damaged or degraded by trace components. This is illustrated by the following examples:

- The purity of monomers used in polymerisation reaction is important when trace amounts of foreign substances can cause chain termination or branching.
- The materials employed for catalytic processes are crucial as the trace constituents often determine the active life of a catalyst.
- Quality controls also require trace analysis of finished products for which trace components could involve possible problems of coloration (aromatics at parts per

million (ppm) may be sufficient for coloration of a light cut), degradation or undesirable odours (*e.g.* sulphur compounds) or may involve health hazards.

Analytical problems related to atmospheric, soil or water pollution could also be mentioned but are outside the scope of this paper.

Here we focus on the analysis of organic components present at trace concentration in “organic” complex mixtures such as hydrocarbon mixtures, petrochemical, petroleum or oil samples, typical feeds and products of refinery and petrochemical processes. As described previously, it is generally accepted that the range of concentration for trace analysis in this case is somewhat higher than those in the field of trace determination by elemental analysis.

In this context, this paper aims to point out the interest and advantages of multidimensional gas chromatography as a powerful tool for trace analysis, whatever the chromatographic detector involved. Here, the success of trace analysis mainly depends on the separation step. Indeed, even if selective or informative detectors can alleviate the effects of peak co-elution by deconvoluting merged peaks, selective detection is only successful if different responses are produced for the individual compounds that are included in a merged peak. For trace analysis, enhancement of peak capacity using selective or informative detectors could be very costly if chromatography of a truly complex sample is carried out on a single column. Multidimensional gas chromatography offers an attractive alternative to rapidly expand peak capacity.

General Interest of Gas Chromatography for Performing “Trace Analysis”

As trace analysis often requires the ability to separate a component or a class of components from complex mixtures, gas chromatography (GC) appears to be a tool of choice for performing the analysis of trace components since this technique is compatible with most of products from the petroleum industry [1].

Indeed, the conventional gas chromatography using modern high resolution capillary columns offers high peak capacity, which enables the separation of more than 500 components [2, 3]. However, it fails to separate all the individual compounds from complex mixtures such as products from the main process of refinery (conversion process, etc.) or other chemical process. Therefore, sample preparation by multistep solid phase extraction analysis or liquid chromatography (LC) is frequently used to characterise (often a part of) the sample, at the expense of very long analysis times and complex instrumentation.

To overcome these limitations, on-line hyphenated analytical procedures have been developed in the past for trace analysis [4]. With the introduction of multidimensional

or comprehensive two-dimensional gas chromatography (MDGC and GC \times GC, respectively), dedicated hyphenated techniques have now become available for a deeper insight into complex mixtures and are suitable for the separation and the identification of trace solutes into complex mixtures.

This paper, thus, aims to describe in more detail the principles of MDGC and GC \times GC, their objectives and advantages in the case of trace analysis, their instrumentation and the requirements for trace analysis and, finally, several recent applications in the petroleum industry.

1 HYPHENATED SYSTEMS IN CHROMATOGRAPHY

In analytical chemistry, *hyphenation* is a term currently used referring to the hyphen that connects the various acronyms of analytical procedure *e.g.* LC-MS (mass spectrometry), or GC-IR (infrared spectrometry) and can be broadly defined as all types of combinations of two or more different analytical systems.

There are two different classes of such combined systems [1, 4]. A combination involving a separation system (chromatography) and a detection device (spectrometric or specific detector) can be called *hyphenated system*. In this paper, another class of hyphenated systems used for unravelling complex mixtures at trace level will be described in more detail: hyphenation of two different separation systems or on-line coupling of two different columns as *coupled-column techniques*.

1.1 Multidimensional Gas Chromatography MDGC

Among these techniques, *multidimensional gas chromatography* (MDGC) has become by far one of the most important techniques in the petroleum industry and in the related areas of interest [4-6]. Its state of art, its principle and advantages for performing trace analysis will be discussed in the next sections.

According to the classical terminology in chromatography [7], separations are commonly called two- or multi-dimensional when separation of all or some selected groups of the sample's components are repeated in two or more analytical chromatographic columns of different polarity [8]. Therefore, each dimension of separation is associated to a specific type of stationary phase and to a specific molecular interaction developed between the stationary phase and the solute.

To be multidimensional, the system requires additional columns coupled in series to the primary column in which the first separation is performed. The continuous transfer of the effluent or the transfer of selected fractions, or cuts, from the first to another column is achieved by the carrier gas flow which can be diverted to an exit ("venting") or reversed for backflush by flow rate switching between the columns. This

necessary switching of the carrier gas flow rate can be operated either by valves or in the valve-less mode. The latter mode is preferred when separations using high-resolution capillary columns are to be performed (see also Section 2.2.1 and 2.2.2). By the transfer of selected cuts from one column to another (different polarity and selectivity of the separation), the resolution between elution peak groups which are contained in such cuts is improved. This particular mode of operation in MDGC is called the *heart-cutting technique* [4-7].

The increase of peak capacity of MDGC compared to conventional GC can usually be estimated by saying that the heart-cutting technique provides $n_1 + n_2$ results, where n_1 and n_2 are the peak capacities of the first and the second columns, respectively [5-6]. However, the information gained by the first separation (the chromatographic resolution) is partly lost when the cut is re-injected onto the second dimension, due to trapping or focusing processes (see Section 2).

1.2 Comprehensive Gas Chromatography GC \times GC

Among MDGC, a further distinction can be made between *heart-cut* and *comprehensive* systems [9]. In the former system, only a limited part of the effluent of the first separation column will be directed towards the second one. In comprehensive GC \times GC, the sample is first separated on a high-resolution capillary column in a programmed temperature mode. Using a device called a thermal modulator (see Section 2.2), fractions of the effluent from this first column are focused at regular, short intervals and injected onto a second capillary column which is short and narrow to allow very rapid, isothermal separations [10-12].

The resulting chromatogram can be represented as a two-dimensional plane from which elution peaks emerge:

- the first dimension of this plane represents the retention time on the first column which is usually expressed in minutes;
- the second dimension represents the retention time on the second dimension which is usually expressed in seconds;
- the third dimension represents the signal intensity, although the frequent way to represent a GC \times GC chromatogram is a two-dimensional contour plot.

In this mode of operation, the entire sample is subjected to both separation procedures and reaches the detector. Thus, this approach is truly comprehensive because, rather than a few selected fractions, the whole sample is separated on two different columns and no information gained during the first separation is lost during the second one. The increase of peak capacity in comprehensive GC \times GC is also estimated by saying that this technique provides $n_1 \times n_2$ results where n_1 and n_2 are the peak capacities of the first and the second columns, respectively.

The polarity order is here briefly discussed. Two major properties are involved in retention in gas chromatography [13-14]:

- the volatility of the solute or the vapour pressure p_i ;
- the polarity related to the activity coefficient of the compound towards the stationary phase at infinite dilution γ_i .

In comprehensive GC \times GC, the two dimensions of separation need to be different. This is achieved by selecting a non-polar column for the first dimension, which provides a separation based on the volatility of the analytes called boiling point separation. In that case, all analytes will elute from the first column at different temperatures, but with very similar volatilities at a given retention time. The second separation, which is usually polar and fast enough to be considered as essentially isothermal at the elution temperature from the first dimension column, is completely determined by the activity coefficient, that can be related to polarity, molecular geometry or size.

Thus, the separations in the two dimensions can be made completely independent of each other, *i.e.* orthogonal [15].

1.3 Advantages of Multidimensional GC for Performing "Trace Analysis"

1.3.1 MDGC

MDGC has the aim of detecting all the trace components and performing better identification or quantification of them in a complex organic mixture. This may be achieved by MDGC since the combination of two or more analytical columns is able to offer the following advantages:

- Increasing the peak capacity, especially with the analysis of samples which consist of very many components (better separation ability).
- The use of highly selective analytical columns (without consideration of the matrix's components) for difficult separations.
- Removing, by fore or back flushing from a short analytical pre-column, components of matrix of low volatility or of high retention times.
- Improving, by heart cutting, the determination of trace components eluted close to solvent peaks or major components.

MDGC is consequently well suited to the analysis of target compounds or selected groups of compounds present in complex matrices such as found in petroleum products.

1.3.2 GC \times GC

Clearly, trace analysis in the field of oil and petrochemical industry stands to benefit from the development of a new and extremely powerful separation techniques such as comprehensive GC \times GC. Compared to conventional MDGC, the main advantages of comprehensive GC \times GC are [10-12]:

- A much higher peak capacity, which involves an improved separation of the trace components from other overlapping components. It provides optimal separation of complex mixtures into well-separated individual peaks (peak capacities of 30 000 and integration of more than 5000 peaks are currently achieved).
- A better sensitivity due to the refocusing process in the thermal modulator (see *Section 2.3*) [16]. This allows the accurate determination of low concentrations of specified components in a complex mixture.
- If correct orthogonal conditions are used, chemically related compounds show up as ordered structures, which greatly facilitates group-type analysis and the provisional classification of unknowns [17]. It may provide boiling-point range distribution and polarity distribution and thus increase the amount of information generated per unit time. This latter point is very important for the analysis of trace components, which are usually unknown.

2 INSTRUMENTATION

2.1 General Requirements for Gas Chromatographic Trace Analysis

The first necessity for a gas chromatographic trace analysis is a sufficiently sensitive method of detecting components that have been separated. If trace components are sufficiently well resolved from other constituents, it is possible to increase the limit of detection by using larger samples. If not, it is possible to undertake concentration procedures. It is also necessary to consider the noise level of the whole instrument, as well as the best methods of sampling, sample injection and calibration.

These requirements, which are very general, are beyond the scope of this paper [1].

2.2 MDGC

2.2.1 Valve Based Systems

As described previously, MDGC consists in an arrangement of two or more analytical columns where distinctive segments of effluents from the first column are fed into one or more secondary columns. Figure 1 shows several possible combinations of MDGC. The mechanism by which the effluent is switched from the first to the second column is critical. In conventional MDGC, the so-called heart cutting methodology, discrete fractions (or cuts) of effluent are diverted into a secondary column (*Fig. 1a*) whereas the rest of the sample is discarded. This arrangement presents the disadvantage that components from different cuts may intermix in the second column. The use of traps acting as simple storage devices is one possibility to get around this

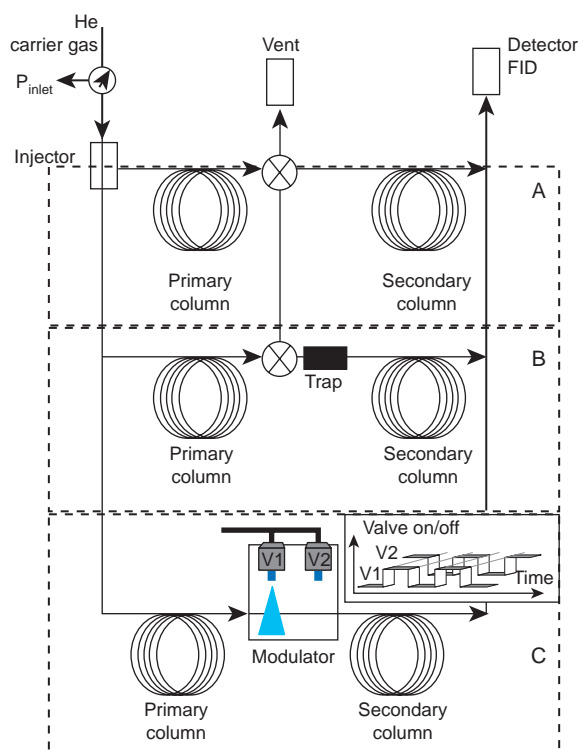

Figure 1

Basic arrangements in MDGC (A) conventional; (B) trap; (C) GC \times GC system implemented with a dual jets CO₂ modulator (the time program of valves is symbolised in the figure).

problem (Fig. 1b). The increasing complexity of trace components has led to the development of selective MDGC systems used in the industry today, such as the PIONA analyser [18]. Several recent reviews describe in more detail the history, instrumentation and features of MDGC [1, 4-6].

2.2.2 Valveless Based Systems (Deans' Type Devices)

As most of the GC separations are to be performed at elevated oven temperatures and because there is a need for high capacity capillary-columns, the switching of the carrier gas flow rate for the transfer of cuts is done without movable parts, so as to prevent adsorption and memory effects. In addition, peaks introduced into the second column may have considerable dispersion (due to void volume in the valve). A new type of device has been recently introduced to overcome these potential limitations: the valveless DEANS type interface or "live switching" between columns [19]. A detailed discussion on this type of operation is beyond the scope of this paper and the reader is referred to the original literature [1, 4-6].

As an example, a system compatible with high-resolution narrow bore capillary columns has been constructed in the authors' laboratory and is described in Figure 2.

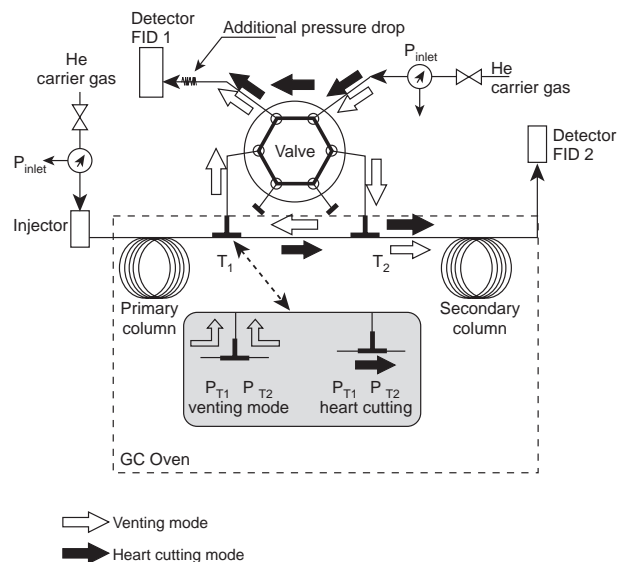

Figure 2

MDGC system based on Deans type pressure balancing.

White and black arrows are indicating the venting and heart cutting modes, respectively. P_{T_i} is the symbol for pressures in the connector T_i .

The column switching system uses a 6-port pneumatic valve provided by VICI, placed in a heated mainframe (200°C) and actuated by air. Two stainless T connectors (Swagelok, 250- μ m i.d.), constitute the column interface and a 6-cm long stainless tube (250 μ m i.d.) is connected between the T pieces. Flame ionisation detectors (FID) are used for monitoring the effluents from the first or the second columns, respectively.

In Figure 2, the arrows show the direction of the carrier gas: the black arrows correspond to heart cutting mode and the white ones to venting mode, respectively. In the venting mode, the effluent eluting from the primary column is vented to the detector FID 1 (white arrows). During the cut, the 6-port valve switching creates a flow inversion in the interface and introduces a small part of the effluent into the secondary column (black arrows). The small fraction transferred to the secondary column is detected by FID 2. Pressure gages are used to ensure the correct flow direction in each mode of operation and an additional pressure drop is used to adjust pressure gradient and flow rates in the system. In particular, P_{T_2} is adjusted to be higher than P_{T_1} in the venting mode. Transfer times between the column and switching times are extremely short making cuts very short and as clean as possible.

2.2.3 Columns Features

Various types of stationary phase combinations are reported in the literature [1, 4-6]. Usually, the first column is non-polar, providing separation based on difference of boiling

points of compounds, and the second dimension is more polar, with separation according to the chemical structure. In this way, the analysis of a few specific target compounds can be achieved (see *Section 3*).

2.3 GC × GC

2.3.1 Instrumentation

Comprehensive two-dimensional gas chromatography is achieved by the hyphenation of two columns of different polarity so that independent “orthogonal” separations can be obtained [10-12, 20]. The heart of any comprehensive GC × GC system is the modulator which connects the two analytical columns and which enables:

- The sampling of the effluent from the first column at high frequency, by trapping a fraction of the effluent in narrow bands onto the column. This fraction is called a chemical pulse.
- The injection of these sharp chemical pulses into the second column.

2.3.1.1 Modulator

Two basic classes of interfaces have been developed so far: thermal modulators and valve based modulators. Thermal modulation, more commonly applied because of a wider application range with better performances, is either heat-based or cryogenic.

The first systems developed by Pr. Philips who pioneered this technique consists in a resistively heated capillary [21] or Sweeper[®] [22] modulator: solutes are trapped by a thick stationary phase capillary connecting the two columns and are remobilized by periodically heating this section through a voltage pulse or a rotating heating arm. This technology demonstrated the potential of GC × GC but it failed in robustness or easy implementation.

Cryogenic modulation can be performed by moving a CO₂ trap along the column (LMCS [23]) or by triggering alternatively two CO₂ jets [24]. A schematic view of a GC × GC system implemented with a dual jet CO₂ modulator is presented in Figure 1c. Recently, a “loop” modulator based on a cryogenic jet of liquid nitrogen and a hot air jet has been introduced [25]. These two latter systems are commercially available under Zoex licensing from the companies *Thermo* (CO₂ jets technology) and *Leco* (N₂ jets-hot air jets technology).

2.3.1.2 Focusing Phenomena

The process of solute focusing/re-injection must be reproducible and non-discriminatory with regard to analyte properties. The advantage of solute focusing by trapping and desorption with high heating and cooling time constants relies on the possibility of reversing the peak dispersion occurring in any chromatographic process [26]. The modulation of a primary peak results in a series of sharp

peaks whose width is below 100 ms. Because of the law of mass conservation, the narrow peaks have a high amplitude. The signal intensity enhancement is typically 10-70 fold higher in GC × GC than in GC. However, regarding the analyte detectability, the signal to noise (S/N) ratio has to be evaluated. As GC × GC requires high acquisition frequencies of detectors (minimum 100 Hz) to properly define very narrow peaks, the expected signal intensity enhancement is reduced. However, a sensitivity enhancement by a factor 5 is generally achieved [27], which is a great advantage for performing trace analysis.

The modulation period is a key parameter for correct tuning of GC × GC separations. A compromise nevertheless has to be made between a sufficient sampling of primary peaks obtained by a high modulation frequency (3-4 samples per peak are recommended [28]) and a modulation period higher than the maximum retention time in the second dimension, to avoid the so-called wrap-around effect. This phenomenon occurs when compounds strongly retained in the second dimension are eluted during the following modulation cycle, inducing overlap between compounds having different boiling points.

2.3.2 Chromatographic Columns Features

Since GC × GC system relies upon fast analysis of accumulated bands, it is usual for the first dimension to give a normal GC elution and the second dimension to be a fast separation column [10-12, 29]. The features of the first dimension are not crucial versus the ones of the second column: the second dimension must enable the complete separation of pulsed bands to be achieved within the modulation period of the system. This is most effectively achieved by use of short, narrow bore thin film column. A typical column set might comprise of a 25 m × 0.32 mm × 0.25 μm column as the first dimension with a 1 m × 0.1 mm × 0.1 μm column as the second dimension.

Considering the nature of the stationary phases, it is necessary to use analytical columns that provide independent separation mechanisms in the first and the second dimensions in order to create orthogonal separation conditions. This is because it is considered that every separation in GC is based on the volatility and their interaction with the stationary phase by the means of hydrogen bonding, π-π interaction, etc. Therefore, in order to achieve orthogonality, the first dimension is has to be a non-polar phase such as 100% dimethylpolysiloxane.

3 SELECTED APPLICATIONS OF TRACE ANALYSIS

3.1 MDGC

Several recent reviews [1, 4-6] have demonstrated the high interest in the field of trace analysis of this technique that is

often used to separate polar solutes (at the ppm level) from hydrocarbons. Analysis of low concentrations such as $\mu\text{g/g}$ levels of phenol in fluid-catalytically cracked (FCC) products [1, 4-6, 11] or oxygenated compounds in gasoline have been reported: separation of these compounds from hydrocarbons were achieved using a polar second column as second stationary phase. A normalised standard method from ASTM has been built on this principle to determine traces of oxygenated compounds in C_4 cuts. This method has recently been improved to provide quantification of oxygenated compounds at $\mu\text{g/g}$ levels (see Section 3.1.3).

3.1.1 Separation of a Coal-Derived Gasoline Fraction

MDGC using the so-called “heart cutting” technique has been performed for analysing polar compounds such as ketones, alcohols and nitriles as well as isomers including aromatic hydrocarbons (see Fig. 3) contained in a gasoline fraction from coal liquefaction [6]. For the separations shown, a coupling of a polar polyethylene glycol and a non-polar methyl polysiloxane OV 1 capillary columns was applied. The polar column was operated isothermally whereas the non-polar main or second column was operated with temperature programming. In chromatogram A, the polar components (# 1 to 10, see Fig. 3) are shifted far beyond the bulk of unresolved volatile hydrocarbon isomers in the carbon number range from C_4 to C_8 . The hydrocarbon isomers could be well resolved with a temperature program, which began at sub-ambient temperatures (separation B on Figure 3). The pre- or first separation is characterised by long retention for the polar components, ketones, nitriles and alcohols in the highly polar column.

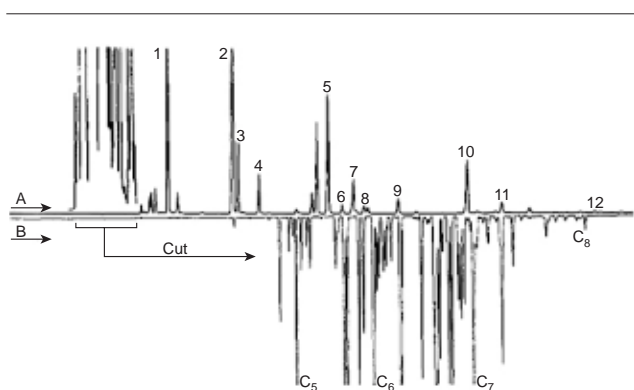

Figure 3

Analysis of a coal derived gasoline fraction applying MDGC. 1 = acetone, 2 = butan-2-one, 3 = benzene, 4 = isopropylmethyl ketone, 5 = isopropanol, 6 = ethanol, 7 = toluene, 8 = propionirile, 9 = acetonitrile, 10 = isobutanol, 11 = 1-propanol, 12 = 1-butanol. Conditions: see ref. [5]

The resolution of the hydrocarbon group is very poor because of the weak and unselective intermolecular

interaction of the non-polar compounds with the polar stationary phase. This application can be adapted for the quantification of low levels of any polar compound in a hydrocarbon matrix.

3.1.2 Determination of Trace Levels of Normal Paraffins in Deparaffinized Kerosene (Dewaxing Process)

The determination of trace levels of *n*-alkanes in middle distillation fractions, with boiling points up to 250°C , is a very relevant issue in the field of petroleum industry for monitoring dewaxing process to maintain product specifications. Owing to the number of isomers contained in middle distillate fractions and the low quantity of alkanes (ranging from 50 to 2000 ppm), no single high-resolution capillary column is able to provide a complete separation of all these compounds. The limitations of HRGC in terms of stationary phases and temperature conditions for the quantification of *n*-alkanes and the nature of overlapping hydrocarbons have been previously reported elsewhere [30-31].

MDGC has been implemented using the so-called “heart cutting” technique by the transfer of selected cuts, among which are those containing *n*-alkanes, from one column to another of different polarity. The resolution should then be improved, enabling a better quantification of the *n*-alkanes. However, very few studies have dealt with the separation of solutes having low differences in polarity such as between *n*-alkanes and other types of hydrocarbons which could be eluted (for instance, branched alkanes, naphthenes or aromatics). Here, the choice of the stationary phase, *i.e.* the selectivity of each column, is more critical. The chromatograms of effluent from the dewaxing process and obtained successively by elution from the first column, venting mode and heart cutting mode are shown in Figure 4.

Owing to their very low concentration (about 50 to 2000 ppm) in the deparaffinized sample, elution peaks of *n*-alkanes are partially masked or totally overlapped by other hydrocarbons on the chromatogram of Figure 4a. The regions corresponding to the elution of *n*-alkanes are indicated by black marks. Very sharp cuts are seen on Figure 4b corresponding to the small amounts of the effluent that were introduced to the second column. The width of the cut depends on the complexity of the chromatographic background around each of the *n*-paraffins. After heart cutting, *n*-paraffins are better separated from other compounds, allowing their quantification (Fig. 4c). However, the separation shown in Figure 4c still appears as complex, underlining the fact that other compounds are co-eluted and transferred with the *n*-alkanes from the first column. Despite the selectivity and the separating power MDGC, it appears that several hydrocarbons elute with *n*-alkanes (Fig. 4c). Effluents of dewaxing process were spiked with *n*-paraffins (Table 1) and were quantified using an internal calibration.

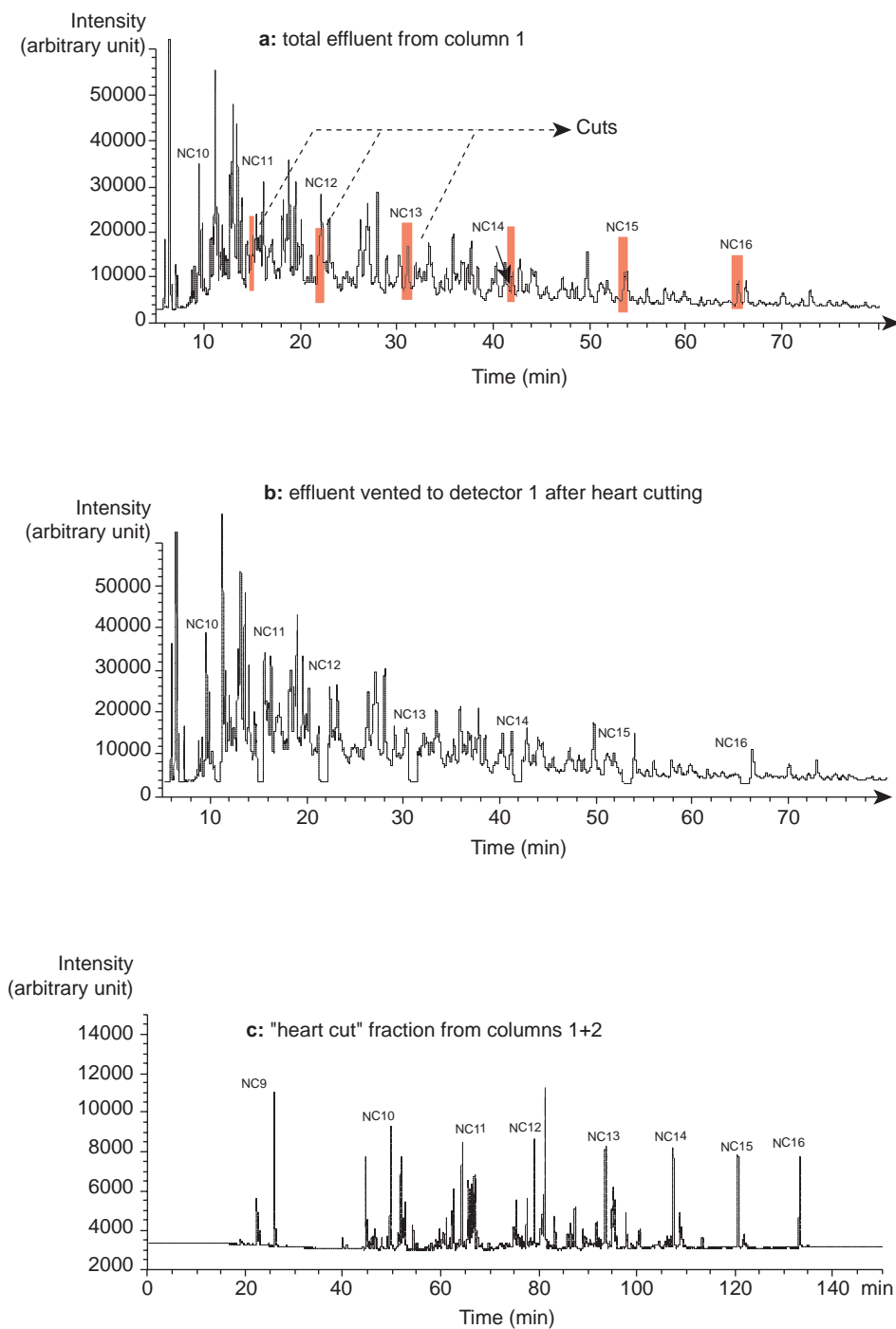

Figure 4

Chromatograms obtained from the elution of deparaffinized kerosene from the first column (total effluent, A), from the first column after heart cutting (venting mode, B) and from the second column (heart cutting of dewaxing kerosene, C). The cuts are indicated by overlapping a box in the region of n-alkanes.

TABLE 1

Quantification of a dewaxing kerosene spiked with known concentration (2000 ppm) of *n*-paraffin

Conditions: Innowax (60 m × 0,25 mm × 0,25 μm) as column 1 and OV1 (60 m × 0,25 mm × 0,5 μm) as Colonne 2; Oven temperature programmed from 5°C (1 min) to 220°C at 1.5°C/min rate. Time intervals of switching programmed upon the retention times of *n*-alkanes on the first column. Constant inlet pressure of carrier gas at 171,7 kPa for two columns and 109.9 kPa for one single column, respectively.

Solutes: nC9: nonane; nC10: decane; nC11: undecane; nC12: dodecane; nC13: tridecane; nC14: tetradecane; nC15: pentacane; nC16: hexadecane.

n-paraffins	Weighted content (ppm)	Mean* (ppm)	Accuracy* (%)	SD* (%)
nC10	1527	1485	2.76	1.61
nC11	1773	1616	8.86	3.50
nC12	1896	1808	4.65	1.85
nC13	1906	1702	10.70	2.56
nC14	1913	2105	6.70	3.36
nC15	1816	2145	13.15	2.60
nC16	2068	1964	5.04	2.41

* 10 replicate injections

Table 1 shows acceptable agreement between measured and calculated weights using *n*-octane as internal standard. Moreover, the fidelity (SD, standard deviation) of the system is compatible with routine analysis, showing that this system is able to provide quantitative information on the composition of effluents from dewaxing process using sequential heart-cuts.

3.1.3 Determination of Traces of Oxygenated Compounds in a C₄ Cut

The determination of ppm and sub-ppm levels of alcohols and aldehydes in different hydrocarbon matrices is very important for a petrochemical analysis laboratory because the level of the oxygenates directly influences product quality, catalyst poisoning, or plant pollution. The C₄ cut, *i.e.* the petroleum cut whose final boiling point corresponds to C₄, is widely used as feed for petrochemical processes and currently requires the quantification of oxygenated compounds. MDGC has been broadly used for the determination of oxygenated compounds at trace levels in C₄ cuts, based on the standard method ASTM D4815. Indeed, this method provides quantification of oxygenated compounds to 0.1% w/w using macrobore packed columns. An improved analytical system, as described in Figure 1a for the heart-cutting mode, using two specific porous-layer-open-tubular chromatographic columns, is able to extend the concentration range of oxygenated compounds that can be analysed down to 1 ppm. The method requires a gas chromatograph equipped with two plot chromatographic columns, a split/splitless injector, a 6-port rotary valve, and a single flame ionisation detector (FID) as described in Figure 5.

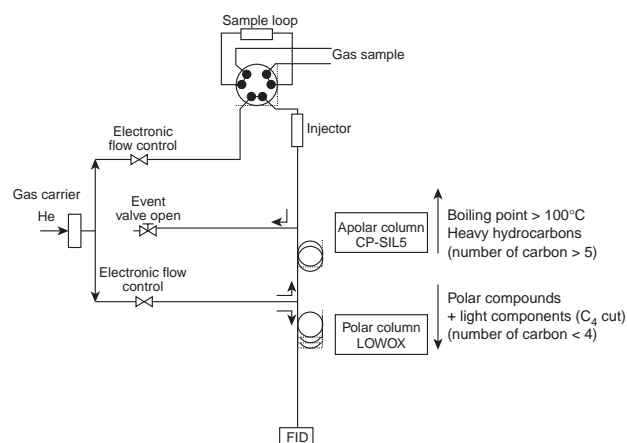

Figure 5

Scheme of the analytical system in backflush position.

The first analytical column is an apolar pre-column (CP-SIL 5CB from Varian inc., 25 m × 0.53 mm × 0.5 μm), which enables a separation of components according to their boiling point order. After the elution of the C₄ cut from the first column, a 6-port valve is switched in order to transfer solutes having a boiling point below 100°C onto the polar analytical column (LOWOX from Varian inc., 12.5 m × 0.53 mm × 10 μm). The heavy compounds are backflushed to the vent whereas light hydrocarbons and alcohols, ethers, and other polar components, which were contained into the C₄ cut, are separated onto the second column according to their polarity. This highly polar column separates the light fractions into hydrocarbons fraction and individual oxygenated compounds at very low levels of concentration (1 to 10 ppm).

This method is successful in quantifying oxygenated compounds in a C₄ matrix spiked with 5 ppm of each compound. An example of a chromatogram for a 5 ppm mixture is given in Figure 6 and the concentration of each component is indicated in the caption.

3.2 GC × GC

Comprehensive GC × GC is expected to improve trace analysis owing to the high peak capacity and the increase in sensitivity due to peak compression [10-12, 16, 26-28]. In a recent paper for example [32], it was demonstrated that GC × GC dramatically improves the separation of key flavours in dairy products. As a consequence, identification and, more importantly, quantification down to the ng/g level can be performed more reliably because of the disappearance of background interference.

Trace analysis of oxygenated products in gasoline [33-34], of polynuclear aromatic hydrocarbons in complex matrices [35], of oxygenated and aromatic compounds in water samples using headspace solid-phase microextraction [36-37],

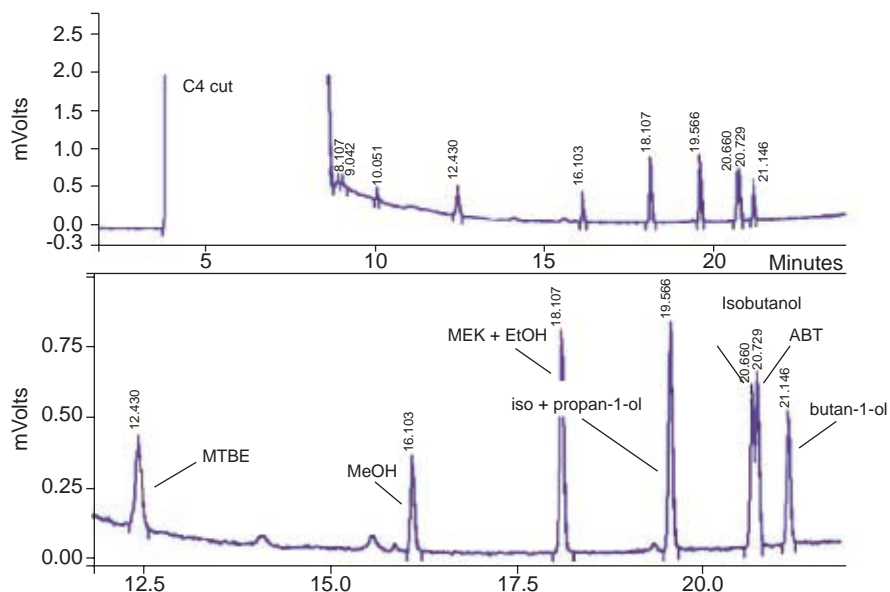

Figure 6

Chromatogram obtained using MDGC for performing the analysis of trace of oxygenated compounds in C_4 cut.

Conditions: Temperature programmed from 50 to 240°C at 10°C/min; He flow rate = 5 ml/min; inter column pressure 10 psi; backflush time = 7.00 min.

Concentration: MTBE (methyl tertio butyl ether) = 5.12 ppm, Methanol = 4.83 ppm; MEK (methyl ethyl ketone) = 4.99; Ethanol = 5.33; isopropanol = 5.04; isobutanol = 5.15; ABT (tertio butanol) = 5.15 ppm; butanol = 4.84 ppm.

of petroleum biomarkers [38-39] have been recently reported demonstrating the high interest of this technique.

Other papers reported, as lower limits of quantification, 3-10 ppm for the determination of essential oil markers in perfume mixtures [40] or 5-140 ng/mL for 20 selected pesticides in fruit samples [41].

The interest of GC × GC for trace analysis in petrochemical products is discussed via two application examples [24, 42]. For these examples, comprehensive GC × GC analyses are achieved using a home made dual jet CO_2 modulator as described elsewhere [42]. A Matlab program, written in-house, performs data processing.

3.2.1 Dehydrogenation of Normal Paraffins

Linear olefins are widely used in petrochemistry owing to their high reactivity and can be obtained by dehydrogenation of normal paraffins. This reaction has a low conversion yield (maximum 20%). By-products such as isoparaffins, cracked products, aromatics and diolefins (involved in the coking of the catalyst at high temperature), are also produced at very low levels of concentration. Qualitative and quantitative information on the composition of these minor products are needed to optimise the process through a better understanding of thermodynamics.

Presently, conventional GC does not provide a detailed analysis because of overlapping of peaks due to products

belonging to different chemical groups, present at different concentration levels. Even GC-MS cannot solve this problem since deconvolution of mass spectra at trace level would not be possible for quantitative purposes and routine type analysis.

Figure 7 shows GC × GC chromatograms of the feed (A), and the products of conversion of *n*-paraffins into *n*-olefins at 10% (B) and at 20% (C) yields. The feed principally contains *n*-paraffins from C_{10} to C_{14} . At least two novel chemical classes can be clearly identified in the products (B and C). According to a preliminary study of a synthetic mixture of hydrocarbons, these compounds were assigned to be aromatics and diaromatics [42]. A repetitive pattern of hydrocarbons, shown in enlarged view in the insert of Figure 7, can be identified near each *n*-paraffin: isoparaffins, olefins, diolefins, and aromatics. The selectivity of the second dimension allows these different chemical groups to be separated.

Quantification was compared between conventional GC and comprehensive GC × GC. Even if split injections are achieved, discrimination is not likely to occur because the cut is relatively narrow. An excellent agreement between both techniques was found for *n*-paraffins: 98.35% determined in comprehensive GC × GC and 98.39% in conventional GC. However, the concentrations of some other compounds are sometimes very different, with higher contents obtained in

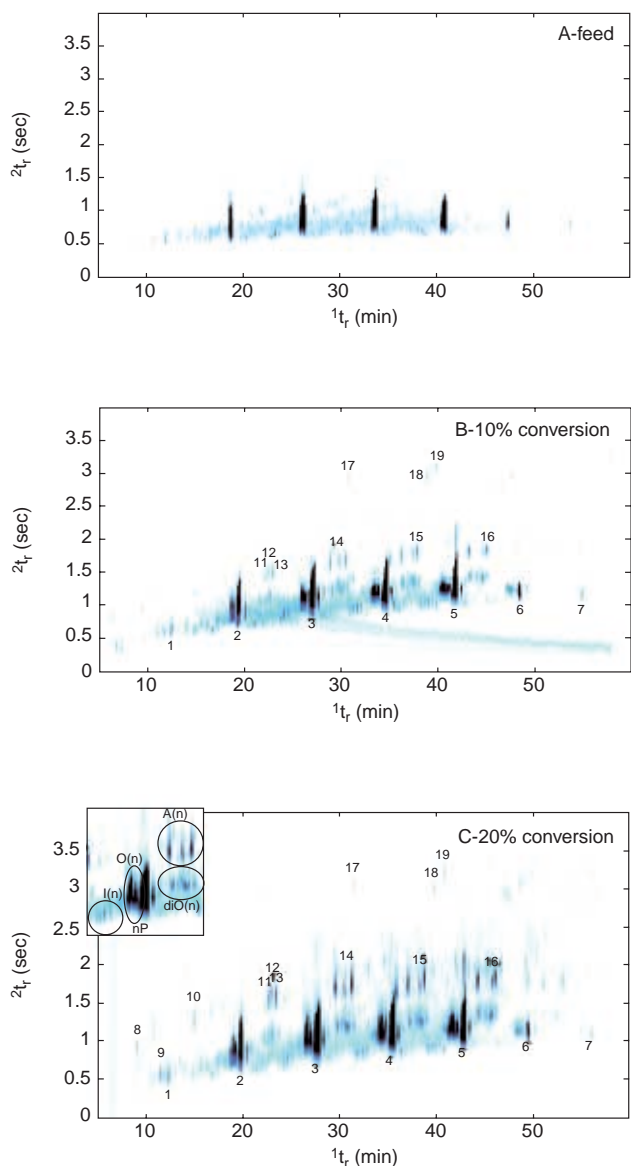

Figure 7

Comprehensive GC×GC chromatograms of the feed (A) of dehydrogenation process and the products corresponding to conversion at 10% yield (B) and 20% yield (C).

Conditions: Columns: PONA (20 m×0.2 mm i.d.; 0.5 μm) + BPX50 (1.1 m×0.1 mm i.d.; 0.1 μm) - T: from 50 to 170°C at 2°C/min - P = 250 kPa.

GC. For instance, the concentration of naphthalene determined in comprehensive GC×GC is lower than in GC (41 ppm instead of 150 ppm at 20% conversion yield). This may be explained by the integration of co-eluted species at very low concentrations in GC, which leads to overestimated results.

Note that all aromatic and diaromatic compounds are baseline resolved in GC×GC, which is not the case in conventional GC. This is shown in the example presented in

Figure 8, which corresponds to chromatograms obtained in GC and GC×GC at the elution time of naphthalene. In conventional GC, naphthalene is coeluted with other compounds and the peak is not clearly resolved from the baseline. The elution zone of naphthalene in GC×GC was expanded to highlight the four secondary separations corresponding to the modulation of this compound. Naphthalene (marked with an asterisk) is completely resolved from other hydrocarbons of the same volatility that were introduced at the same time in the second column. Moreover a S/N enhancement of a factor 6 is achieved. Hence, more accurate data for trace compounds are obtained in GC×GC.

3.2.2 Fischer-Tropsch Process

Fischer-Tropsch synthesis, developed in the 1920's, has recently met with renewed interest since petroleum reserves are known to be limited to some decades. In the present context of higher energy demand with stronger environmental concern, alternatives to petroleum are being developed. Fischer-Tropsch technology converts coal, natural gas and low value refinery products into high value clean products. Normal paraffins are the main products formed from hydrogen and carbon monoxide. They can be used for wax production but can be more readily upgraded to fuels. The hydrocracking/hydroisomerisation processes improve their thermal properties at low temperature to allow their blending in a diesel pool. The resulting "green" fuels, containing no sulfur and no aromatics, present good combustion characteristics (with a high cetane number). During the reaction, other products are formed: isoparaffins, olefins and alcohols. Their correct determination is thus of importance for the process.

In conventional GC, alcohols are coeluted with isoparaffins. This obviously leads to a conflicting integration. Moreover, only alcohols with the hydroxy group substituted in position 1 are identified in GC. On the contrary, the selectivity of the second dimension in GC×GC enables the separation of alcohols from other hydrocarbons: a better integration can be performed (Fig. 9). GC×GC provides thus enhanced information on sample composition because it allows the detection of about four isomers of alcohols at a given carbon number. The position of the hydroxy function is not precisely identified and must be evaluated in the future using hyphenation with Time of Flight Mass Spectrometry. Comparing quantitative results, GC and GC×GC give comparable contents of n-paraffins (relative differences are between 1.5 and 4%), while a higher content of alcohols is found when GC is used (from 10 to 30% of relative difference for alcohol contents in the range 200-5000 ppm, depending on the carbon atom number). Once again, this overestimation is related to the coelution of alcohols with olefins in GC.

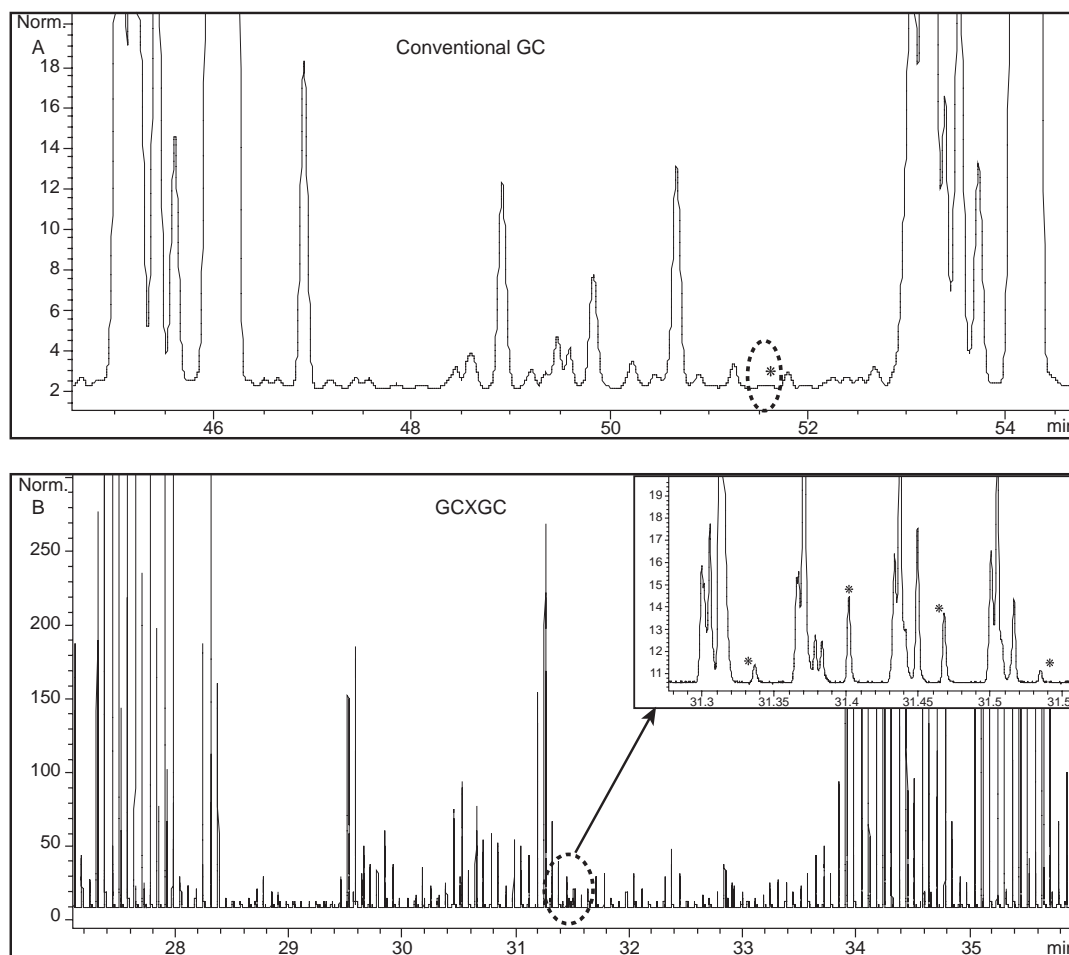

Figure 8

Chromatograms of the product converted at 14% obtained in GC (A) and in GC×GC (B). The elution zone of naphthalene, indicated with the symbol *, is circled with a dotted line and has been magnified in Figure B.

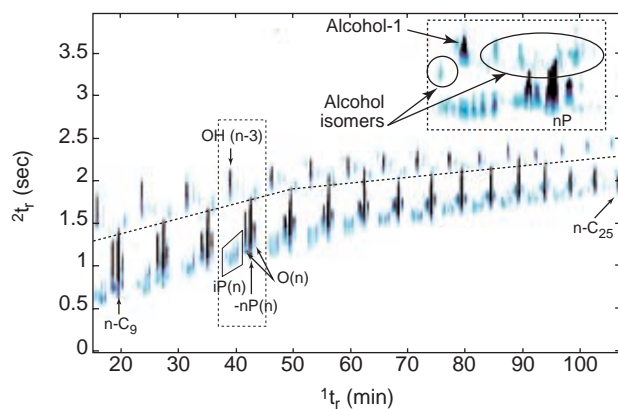

Figure 9

Comprehensive GC×GC chromatogram of a Fischer-Tropsch product.

Conditions: Columns: PONA (20 m×0.2 mm i.d.; 0.5 μm) + BPX50 (1.1 m×0.1 mm i.d.; 0.1 μm) - T: from 50 to 280°C at 2°C/min - P = 250 kPa.

CONCLUSION

Since its introduction in the field of the analysis of oil and petrochemical samples in the beginning of 50's, gas chromatography has progressed considerably towards a better separation and identification of hydrocarbons and related compounds.

The combination of several steps or dimensions of separation, leading to multidimensional gas chromatography, succeeds in providing high performance analytical systems for trace analysis: routine analysis for identification and determination of target compounds in highly complex mixtures can be achieved. Although MDGC is a mature technique, new developments are still appearing, such as comprehensive GC×GC. This new technique has the potential to dramatically increase the resolution power and can be applied successfully to extremely complex mixtures for performing a wide variety of trace analyses. The emergence of GC×GC should be able to offer a solution for

a better comprehensive characterisation and determination of target compounds at trace level.

These techniques offer an attractive alternative for performing trace analysis, without the expense of very long analysis time (sample preparation, pre-treatment step, etc.) or complex and expensive instrumentation (detectors, etc.).

REFERENCES

- 1 Blomberg, J., Schoenmakers, P.J. and Brinkman, U.A.Th. (2002) Gas Chromatographic Methods for Oil Analysis. *J. Chromatogr. A*, **972**, 137-173.
- 2 Teng, S.T., Williams, A.D. and Urdal, K. (1994) *J. High Resol. Chromatogr.*, **17**, 469-475.
- 3 Di Sanzo, F.P., Lane, J.L. and Yoder, R.E. (1988) Application of the State-of-the-Art Multidimensional High Resolution Gas Chromatography for Individual Component Analysis. *J. Chromatogr. Sci.*, **26**, 206-209.
- 4 Mondello, L., Lewis, A. and Bartle, K. (2002) Multidimensional Gas Chromatography, Ed. Wiley, London.
- 5 Bertsch, W. (1999) Two-Dimensional Gas Chromatography. Concepts, Instrumentation, and Applications. *J. High Resol. Chromatogr.*, **22**, 647-655.
- 6 Schomburg, G. (1995) Two-dimensional Gas Chromatography. Principle, Instrumentation and Methods. *J. Chromatogr. A*, **703**, 309-325.
- 7 Giddings, J.C. (1987) Concepts and Comparisons in Multidimensional Separation. *J. High. Resol. Chromatogr. Comm.*, **10**, 319-323.
- 8 Giddings, J.C. (1995) Sample Dimensionality: A Predictor of Order-disorder in Component Peak Distribution in Multidimensional Separation. *J. Chromatogr. A*, **703**, 3-15.
- 9 Schoenmakers, P.J., Marriott, P. and Beens, J. (2003) Nomenclature and Conventions in Comprehensive Multidimensional Gas Chromatography, *LC-GC*, **16**, 335-339.
- 10 Bertsch, W. (2000) Two-Dimensional Gas Chromatography. Concepts, Instrumentation and Applications. Part 2: Comprehensive Two-Dimensional Gas Chromatography. *J. High Resol. Chromatogr.*, **23**, 167-181.
- 11 Dallüge, J., Beens, J. and Brinkman, U.A.Th. (2003) Comprehensive Two-Dimensional Gas Chromatography: a Powerful and Versatile Analytical Tool. *J. Chromatogr. A*, **1000**, 69-108.
- 12 Phillips, J.B. and Xu, J. (1995) Comprehensive Multidimensional Gas Chromatography. *J. Chromatogr. A*, **703**, 327-334.
- 13 Beens, J., Tijssen, R. and Blomberg, J. (1998) Prediction of Comprehensive Two-dimensional Gas Chromatographic Separations. A Theoretical and Practical Exercise. *J. Chromatogr. A*, **822**, 233-251.
- 14 Ong, R. and Marriott, P. (2002) A Review of Basic Concepts in Comprehensive Two-Dimensional Gas Chromatography. *J. Chromatogr. Sci.*, **40**, 276-291.
- 15 Venkatramani, C.J., Xu, J. and Phillips, J.B. (1996) Separation Orthogonality in Temperature-Programmed Comprehensive Two-Dimensional Gas Chromatography. *Anal. Chem.*, **68**, 1486-1492.
- 16 Lee, A.L., Bartle, K.B. and Lewis, A.C. (2001) A Model of Peak Amplitude Enhancement in Orthogonal Two-Dimensional Gas Chromatography. *Anal. Chem.*, **73**, 1330-1335.
- 17 Ong, R., Marriott, P. and Morrison, P. (2002) Influence of Chromatographic Conditions on Separation in Comprehensive Gas Chromatography. *J. Chromatogr. A*, **962**, 135-152.
- 18 Curvers, J. and Van den Engel, P. (1988) Automated Multidimensional Gas Chromatographic PNA - Analysis of Hydrocarbon Type Samples, PONA Analysis Using a Reversible Olefin Trap. *J. Chromatogr. Sci.*, **26**, 271-274.
- 19 Deans, D.R. (1981) *J. Chromatogr.*, **203**, 19-32.
- 20 Marriott, P. and Shellie, R. (2002) Principles and Applications of Comprehensive Two-dimensional Gas Chromatography. *Trends in Analytical Chemistry*, **21**, 573-583.
- 21 Liu, Z. and Phillips, J.B. (1991) Comprehensive Two-Dimensional Gas Chromatography Using an On-Column Thermal Modulator Interface. *J. Chromatogr. Sci.*, **29**, 227-231.
- 22 Phillips, J.B., Gaines, R.B., Blomberg, J. and Ledford Jr., E.B., (1999) A Robust Thermal Modulator for Comprehensive Two-Dimensional Gas Chromatography. *J. High Resol. Chromatogr.*, **22**, 3-10.
- 23 Marriott, P.J. and Kinghorn, R.M. (1997) Longitudinally Modulated Cryogenic System. *Anal. Chem.*, **69**, 2582-2588.
- 24 Beens, J., Adahchour, M., Vreuls, R., Van Altena, L. and Brinkman, U. (2001) Simple, Non-moving Modulation Interface for Comprehensive Two-Dimensional Gas Chromatography. *J. Chromatogr. A*, **919**, 127-132.
- 25 Technical Note KT030606-1, www.zoex.com
- 26 De Geus, H.J., De Boer, J., Brinkman, U.A.Th., Ledford Jr., E.B. and Phillips, J.B. (1998) Increased Signal Amplitude Due to Mass Conservation in a Thermal Desorption Modulator. *J. High Resol. Chromatogr.*, **21**, 411-413.
- 27 Kinghorn, R.M. and Marriott, P.J. (1998) Enhancement of Signal-to-Noise Ratios in Capillary Gas Chromatography by Using a Longitudinally Modulated Cryogenic System. *J. High Resol. Chromatogr.*, **21**, 32-38.
- 28 Murphy, R.E., Schure, M.R. and Foley, J.P. (1998) Effect of Sampling Rate on Resolution in Comprehensive Two-Dimensional Liquid Chromatography. *Anal. Chem.*, **70**, 1585-1594.
- 29 Beens, J., Blomberg, J. and Schoenmakers, P.J. (2000) Proper Tuning of Comprehensive Two-Dimensional Gas Chromatography to Optimize the Separation of Complex Oil Fractions. *J. High Resol. Chromatogr.*, **23**, 182-188.
- 30 Hal, S., Kuras, M. and Popl, M. (1981) *Analysis of Complex Hydrocarbon Mixtures*, Elsevier, Amsterdam.
- 31 Krupcik, J., Repka, D. and Korenkova, S. (1998) Two Dimensional Capillary Gas Chromatographic Analysis of C9-C18 n-alkanes in Kerosene Type Petroleum Distillation Fractions. *Petroleum and Coal*, **40**, 183-187.
- 32 Adahchour, M., van Stee L.L.P., Beens, J., Vreuls, R.J.J. Batenburg, M.A. and Brinkman, U.A.T. (2003) *J. of Chromatogr. A*, 1019, 157-172.
- 33 Frysinger, G.S., Gaines, R.B. and Ledford Jr., E.B. (1999) Quantitative Determination of BTEX and Total Aromatic Compounds in Gasoline by Comprehensive Two-Dimensional Gas Chromatography (GC x GC). *J. High Resol. Chromatogr.*, **22**, 195-200.
- 34 Frysinger, G.S. and Gaines, R.B. (2000) Determination of Oxygenates in Gasoline by GC x GC. *J. High Resol. Chromatogr.*, **23**, 197-201.
- 35 Cavagnino, D., Magni, P., Zilioli, G. and Trestianu, S. (2003) Comprehensive Two-Dimensional Gas Chromatography Using Large Volume Injection for the Determination of

- Polynuclear Aromatic Hydrocarbons in Complex Matrices. *J. Chromatogr. A*, **1019**, 211-220.
- 36 Gaines, R.B., Ledford Jr., E.B. and Stuart, J.D. (1998) Analysis of Water Samples for Trace Levels of Oxygenate and Aromatic Compounds Using Headspace Solid-phase Microextraction and Comprehensive Two-Dimensional Gas Chromatography. *J. Microcol. Sep.*, **10**, 597-604.
- 37 Beens, J., Dallüge, J., Adahchour, M., Vreuls, R.J.J. and Brinkman, U.A.Th. (2001) Moving Cryogenic Modulator for the Comprehensive Two-Dimensional Gas Chromatography (GC × GC) of Surface Water Contaminants. *J. Microcol. Sep.*, **13**, 134-140.
- 38 Frysinger, G.S. and Gaines, R.B. (2001) Separation and Identification of Petroleum Biomarkers by Comprehensive Two-Dimensional Gas Chromatography. *J. Sep. Sci.*, **24**, 87-96.
- 39 Gaines, R.B., Frysinger, G.S., Hendrick-Smith, M.S. and Stuart, J.D. (1999) Oil Spill Identification by Comprehensive Two-Dimensional Gas Chromatography (GC × GC). *Environ. Science & Technol.*, **33**, 2106-2112.
- 40 Van Mispelaar, V.G., Tas, A.C., Smilde, A.K., Schoenmakers, P.J. and Van Asten, A.C. (2003) Characterisation of Fatty Acids in Biological Oil Samples Using Comprehensive Multidimensional Gas Chromatography. *J. Chromatogr. A*, **1019**, 15-23.
- 41 Zrostlikova, J., Hajslova, J. and Cajka, T. (2003) A Dual Secondary Column Comprehensive Two-Dimensional Gas Chromatography for the Analysis of Volatile Organic Compound Mixtures. *J. Chromatogr. A*, **1019**, 173-179.
- 42 Vendevre, C., Bertoncini, F., Duval, L., Duplan, J.L., Thiébaud, D. and Hennion, M.C. (2004) Comparison of Conventional Gas Chromatography and Comprehensive Two-Dimensional Gas Chromatography for the Detailed Analysis of Petrochemical Sample. *J. Chromatogr. A*, **1056**, 155-162.

Final manuscript received in June 2005

Copyright © 2005 Institut français du pétrole

Permission to make digital or hard copies of part or all of this work for personal or classroom use is granted without fee provided that copies are not made or distributed for profit or commercial advantage and that copies bear this notice and the full citation on the first page. Copyrights for components of this work owned by others than IFP must be honored. Abstracting with credit is permitted. To copy otherwise, to republish, to post on servers, or to redistribute to lists, requires prior specific permission and/or a fee. Request permission from Documentation, Institut français du pétrole, fax. +33 1 47 52 70 78, or revueogst@ifp.fr.